

Intel® Desktop Board D865GBF/D865GLC Product Guide

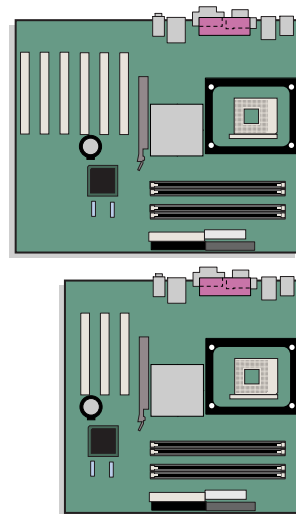

Order Number: C24485-002

Revision History

Revision	Revision History	Date
-001	First release of the Intel® Desktop Board D865GBF/D865GLC Product Guide.	March 2003
-002	Second release of the Intel® Desktop Board D865GBF/D865GLC Product Guide.	May 2003

If an FCC declaration of conformity marking is present on the board, the following statement applies:

FCC Declaration of Conformity

This device complies with Part 15 of the FCC Rules. Operation is subject to the following two conditions: (1) this device may not cause harmful interference, and (2) this device must accept any interference received, including interference that may cause undesired operation.

For questions related to the EMC performance of this product, contact:

Intel Corporation
5200 N.E. Elam Young Parkway
Hillsboro, OR 97124
1-800-628-8686

This equipment has been tested and found to comply with the limits for a Class B digital device, pursuant to Part 15 of the FCC Rules. These limits are designed to provide reasonable protection against harmful interference in a residential installation. This equipment generates, uses, and can radiate radio frequency energy and, if not installed and used in accordance with the instructions, may cause harmful interference to radio communications. However, there is no guarantee that interference will not occur in a particular installation. If this equipment does cause harmful interference to radio or television reception, which can be determined by turning the equipment off and on, the user is encouraged to try to correct the interference by one or more of the following measures:

- Reorient or relocate the receiving antenna.
- Increase the separation between the equipment and the receiver.
- Connect the equipment to an outlet on a circuit other than the one to which the receiver is connected.
- Consult the dealer or an experienced radio/TV technician for help.

Canadian Department of Communications Compliance Statement

This digital apparatus does not exceed the Class B limits for radio noise emissions from digital apparatus set out in the Radio Interference Regulations of the Canadian Department of Communications.

Le présent appareil numérique n'émet pas de bruits radioélectriques dépassant les limites applicables aux appareils numériques de la classe B prescrites dans le Règlement sur le brouillage radioélectrique édicté par le ministère des Communications du Canada.

Disclaimer

Information in this document is provided in connection with Intel® products. No license, express or implied, by estoppel or otherwise, to any intellectual property rights is granted by this document. Except as provided in Intel's Terms and Conditions of Sale for such products, Intel assumes no liability whatsoever, and Intel disclaims any express or implied warranty, relating to sale and/or use of Intel products including liability or warranties relating to fitness for a particular purpose, merchantability, or infringement of any patent, copyright or other intellectual property right. Intel products are not intended for use in medical, life saving, or life sustaining applications. Intel may make changes to specifications and product descriptions at any time, without notice.

Desktop Board D865GBF/D865GLC may contain design defects or errors known as errata which may cause the product to deviate from published specifications. Current characterized errata are available on request.

Contact your local Intel sales office or your distributor to obtain the latest specifications and before placing your product order.

Copies of documents which have an ordering number and are referenced in this document, or other Intel literature, may be obtained from Intel Corporation by going to the World Wide Web site at: <http://www.intel.com/> or by calling 1-800-548-4725.

Intel, Pentium, and Celeron are registered trademarks of Intel Corporation or its subsidiaries in the United States and other countries.

* Other names and brands may be claimed as the property of others.

Copyright © 2003, Intel Corporation. All rights reserved.

Preface

This Product Guide gives information about board layout, component installation, BIOS Setup menus, and regulatory requirements for Intel® Desktop Board D865GBF/D865GLC.

Intended Audience

The Product Guide is intended for technically qualified personnel. It is not intended for general audiences.

Information Layout

The chapters in this Product Guide are arranged as follows:

- [1 Desktop Board Features](#): a summary of product features.
- [2 Installing and Replacing Desktop Board Components](#): instruction on how to install the desktop board and other hardware components.
- [3 Updating the BIOS](#): instructions on how to update the BIOS.
- [4 Using the BIOS Setup Program](#): contents of the BIOS Setup menus and submenus
- [5 Technical Reference](#): information about connectors and desktop board resources.
- [A Error Messages and Indicators](#): information about BIOS error messages and beep codes.
- [B Regulatory Compliance](#): safety and EMC regulations, product certification.

Conventions

The following conventions are used in this manual:



WARNING

Warnings indicate conditions that, if not observed, can cause personal injury.



CAUTION

Cautions warn the user about how to prevent damage to hardware or loss of data.



NOTE

Notes call attention to important information.

Terminology

The table below gives descriptions to some common terms used in the product guide.

Term	Description
GB	Gigabyte (1,073,741,824 bytes)
GHz	Gigahertz (one billion hertz)
KB	Kilobyte (1024 bytes)
MB	Megabyte (1,048,576 bytes)
Mbit	Megabit (1,048,576 bits)
MHz	Megahertz (one million hertz)

Box Contents

- Intel Desktop Board
- I/O shield
- One ATA66/100 IDE cable
- One ATA33 IDE cable
- One SATA cable
- One diskette drive cable
- Quick Reference Guide
- Configuration and battery caution statement label
- Intel® Express Installer CD-ROM

Contents

1 Desktop Board Features

Manufacturing Options	13
Supported Operating Systems.....	13
Desktop Board Components.....	14
Processor	16
Main Memory	17
Intel® 865G Chipset.....	18
Graphics Subsystem	18
Audio Subsystem	18
Flexible 6-Channel Audio with Jack Sensing	18
Input/Output (I/O) Controller	19
LAN Subsystem (Optional)	19
LAN Subsystem Software.....	19
RJ-45 LAN Connector LEDs	20
Hi-Speed USB 2.0 Support.....	20
Enhanced IDE Interface	21
Accelerated Graphics Port (AGP).....	21
BIOS	21
PCI Auto Configuration	21
IDE Auto Configuration	21
Security Passwords	22
Chassis Intrusion.....	22
Power Management Features	22
ACPI.....	22
Power Connectors	22
Fan Connectors.....	23
Fan Speed Control (Intel® Precision Cooling Technology)	23
Suspend to RAM (Instantly Available PC Technology).....	23
Resume on Ring.....	24
Wake from USB.....	24
Wake from PS/2 Keyboard/Mouse.....	25
PME# Wakeup Support	25
Speaker.....	25
Battery.....	25
Real-Time Clock.....	25

2 Installing and Replacing Desktop Board Components

Before You Begin	27
Installation Precautions	28
Installation Instructions	28
Ensure Electromagnetic Compatibility (EMC) Compliance.....	28
Chassis and Component Certifications	29
Prevent Power Supply Overload.....	29

Place Battery Marking.....	29
Use Only for Intended Applications.....	29
Installing the I/O Shield.....	30
Installing and Removing the Desktop Board.....	31
Installing and Removing a Processor.....	32
Installing a Processor.....	32
Installing the Processor Fan Heat Sink.....	32
Connecting the Processor Fan Heat Sink Cable.....	33
Removing the Processor.....	33
Installing and Removing Memory.....	34
Installing DIMMs.....	35
Removing DIMMs.....	36
Installing and Removing an AGP Card.....	37
Installing an AGP Card.....	37
Removing the AGP Card.....	37
Connecting the IDE Cable.....	38
Connecting the Serial ATA Cable.....	39
Connecting Internal Headers.....	40
Installing a Front Panel Audio Solution.....	41
Setting up the Flexible 6-Channel Audio with Jack Sensing.....	42
Multi-Channel Analog Audio.....	42
Multi-Channel Digital Audio.....	42
Connecting USB 2.0 Headers.....	43
Connecting the Front Panel Header.....	43
Connecting Hardware Control and Power Cables.....	44
Connecting the Chassis Intrusion Cable.....	45
Connecting Fans.....	45
Connecting Power Cables.....	45
Setting the BIOS Configuration Jumper Block.....	46
Clearing Passwords.....	47
Replacing the Battery.....	48
3 Updating the BIOS	
Updating the BIOS with the Intel® Express BIOS Update Utility.....	53
Updating the BIOS with the Iflash Memory Update Utility.....	54
Obtaining the BIOS Update File.....	54
Updating the BIOS.....	54
Recovering the BIOS.....	55
4 Using the BIOS Setup Program	
Maintenance Menu.....	58
Main Menu.....	59
Advanced Menu.....	60
PCI Configuration Submenu.....	61
Boot Configuration Submenu.....	62
Peripheral Configuration Submenu.....	63
ATA/IDE Configuration Submenu.....	65
PATA and SATA Submenus.....	66
Diskette Configuration Submenu.....	68
Event Log Configuration Submenu.....	69

Video Configuration Submenu	70
USB Configuration Submenu.....	71
Chipset Configuration Submenu	72
Fan Control Submenu.....	74
Hardware Monitoring Submenu	75
Security Menu	76
Power Menu	77
ACPI Submenu.....	78
Boot Menu.....	79
Boot Device Priority Submenu	80
Hard Disk Drives Submenu.....	81
Removable Devices Submenu.....	82
ATAPI CD-ROM Drives	83
Exit Menu	84
5 Technical Reference	
Board Connectors	85
Back Panel Connectors	86
Audio Connectors	87
Add-In Card and Peripheral Interface Connectors	88
Desktop Board Resources.....	89
Memory Map	89
DMA Channels	89
Interrupts	90
A Error Messages and Indicators	
BIOS Beep Codes	91
BIOS Error Messages.....	92
B Regulatory Compliance	
Safety Regulations	95
EMC Regulations	95
Product Certification Markings.....	96
Figures	
1. Desktop Board D865GBF Components	14
2. Location of Standby Power Indicator.....	24
3. Installing the I/O Shield	30
4. Location of Desktop Board Mounting Screw Holes.....	31
5. Installing a Processor.....	32
6. Connecting the Processor Fan Heat Sink Cable to the Processor Fan Connector	33
7. Installing a Memory Module	34
8. Dual Configuration Example with Two DIMMs	35
9. Dual Configuration Example with Four DIMMs.....	35
10. Removing the AGP Card.....	37
11. Connecting the IDE Cable.....	38
12. Connecting the Serial ATA Cable.....	39
13. Internal Headers	40
14. Back Panel Audio Connectors for 6-Channel Audio with Jack Sensing	42
15. Location of Hardware Control Headers and Power Connectors	44

16. Location of the BIOS Configuration Jumper Block.....	46
17. Removing the Battery	51
18. Back Panel Connectors.....	86
19. Audio Connectors	87
20. PCI Bus Add-in Card and Peripheral Interface Connectors	88

Tables

1. Desktop Board Differences	11
2. Feature Summary	11
3. Manufacturing Options.....	13
4. Desktop Board Components	15
5. Supported Processors	16
6. RJ-45 10/100 Ethernet LAN Connector LEDs	20
7. RJ-45 10/100/1000 Gigabit Ethernet LAN Connector LEDs	20
8. Front Panel Audio Header Signal Names (J9A2)	41
9. USB 2.0 Headers (J9F1 and J9H1).....	43
10. Front Panel Header (J9J1).....	43
11. Jumper Settings for the BIOS Setup Program Modes (J9J4)	46
12. BIOS Setup Program Menu Bar	57
13. BIOS Setup Program Function Keys.....	58
14. Maintenance Menu	58
15. Main Menu.....	59
16. Advanced Menu	60
17. PCI Configuration Submenu	61
18. Boot Configuration Submenu	62
19. Peripheral Configuration Submenu	63
20. ATA/IDE Configuration Submenu.....	65
21. SATA and PATA Submenus	66
22. Diskette Configuration Submenu.....	68
23. Event Log Configuration Submenu	69
24. Video Configuration Submenu	70
25. USB Configuration Submenu	71
26. Chipset Configuration Submenu	72
27. Hardware Management.....	74
28. Hardware Monitoring Submenu.....	75
29. Security Menu.....	76
30. Power Menu.....	77
31. ACPI Submenu	78
32. Boot Menu	79
33. Boot Device Priority Submenu	80
34. Hard Disk Drives Submenu.....	81
35. Removable Devices Submenu	82
36. ATAPI CD-ROM Drives Submenu.....	83
37. Exit Menu.....	84
38. System Memory Map.....	89
39. DMA Channels.....	89
40. Interrupts	90

41. Beep Codes	91
42. BIOS Error Messages	92
43. Safety Regulations.....	95
44. EMC Regulations	95

1 Desktop Board Features

This chapter summarizes the main features of Intel® Desktop Board D865GBF/D865GLC. Table 1 shows the differences between Desktop Boards D865GBF and D865GLC.

Table 1. Desktop Board Differences

Feature	Desktop Board D865GBF	Desktop Board D865GLC
Form factor	ATX at 9.6-inches by 12.0-inches	microATX at 9.6-inches by 9.6-inches
PCI bus add-in card connectors	Six	Three

Table 2 describes the major features of Desktop Board D865GBF/D865GLC.

Table 2. Feature Summary

Processor	<p>Support for:</p> <ul style="list-style-type: none"> Intel® Pentium® 4 processor (1.60a, 1.80a, 2a, 2.20 GHz or higher) with 800/533/400 MHz front side bus (FSB) frequency in the mPGA478-pin package Intel® Celeron processor (2 GHz or higher) with 400 MHz FSB frequency in the mPGA478-pin package
Main Memory	<ul style="list-style-type: none"> Four 184-pin, 2.5 V SDRAM Dual Inline Memory Module (DIMM) sockets Dual channel 400/333/266 MHz DDR SDRAM interface Designed to support up to 4 GB of system memory <p>NOTE: System resources (such as PCI and AGP) require physical memory address locations that reduce available memory addresses above 3 GB. This may result in less than 4 GB of memory being available to the operating system and applications. For more information about the latest list of tested memory, refer to the Intel World Wide Web site at: http://support.intel.com/support/motherboards/desktop/</p>
Chipset	<p>Intel® 865G chipset consisting of:</p> <ul style="list-style-type: none"> Intel® 82865G Graphics and Memory Controller Hub (GMCH) with Accelerated Hub Architecture (AHA) bus Intel® 82801EB I/O Controller Hub (ICH5) with support for up to six Hi-Speed Universal Serial Bus 2.0 (USB 2.0) ports 4 Mbit Firmware Hub (FWH)
Graphics	<ul style="list-style-type: none"> Intel 865G chipset Integrated Intel® Extreme Graphics 2 1.5 V and 0.8 V only AGP connector Single AGP port via the connector or integrated graphics AGP 3.0 including 1x/4x/8x AGP data transfers and 1x/4x/8x Fast Writes
Audio	<ul style="list-style-type: none"> Intel 865G chipset (AC '97) Flexible 6-Channel Audio with Jack Sensing Analog Devices Inc. codec

continued

Table 2. Feature Summary (continued)

<u>Peripheral Interfaces</u>	<ul style="list-style-type: none"> • Up to eight USB 2.0 ports <ul style="list-style-type: none"> — Four ports routed to the back panel — Four ports routed to the internal USB header • Two IDE interfaces with Ultra DMA-33 and ATA-66/100 support • Two Serial ATA (SATA) connectors • One diskette drive interface • One parallel port • One serial port • One VGA port • PS/2* keyboard and mouse ports
<u>Expansion Capabilities</u>	<ul style="list-style-type: none"> • Up to six PCI bus add-in card connectors (SMBus routed to PCI bus 2) • One AGP connector
<u>BIOS</u>	<ul style="list-style-type: none"> • Intel/AMI BIOS • 4 Mbit symmetrical flash memory • Support for SMBIOS
<u>Power Management</u>	<ul style="list-style-type: none"> • Support for Advanced Configuration and Power Interface (ACPI) • Suspend to RAM (STR) • Wake on USB, PCI, RS-232, PS/2, LAN, and front panel
<u>Hardware Management</u>	<ul style="list-style-type: none"> • Hardware monitor with: <ul style="list-style-type: none"> • Three fan sensing inputs used to monitor fan activity • Temperature sensing • Intel® Precision Cooling Technology fan speed control that automatically adjusts chassis fan speeds based on system temperature • Voltage sensing to detect out of range values

Related Links:

For more information about Intel Desktop Board D865GBF/D865GLC, including the Technical Product Specification (TPS), BIOS updates, and device drivers, go to:

<http://support.intel.com/support/motherboards/desktop/>

Manufacturing Options

Table 3 below describes the manufacturing options for Desktop Board D865GBF/D865GLC.

Table 3. Manufacturing Options

Option	Description
LAN	Intel® 82562EX 10/100 Mbit/sec Platform LAN Connect (PLC) device and RJ-45 connector
Gigabit LAN	Intel® 82540EI 10/100/1000 Mbit/sec Gigabit Ethernet controller and RJ-45 connector

Supported Operating Systems

The desktop board supports the following operating systems:

- Microsoft Windows* 98 SE
- Microsoft Windows Me
- Microsoft Windows 2000
- Microsoft Windows XP

Desktop Board Components

Figure 1 shows the approximate location of the major components on Desktop Board D865GBF.

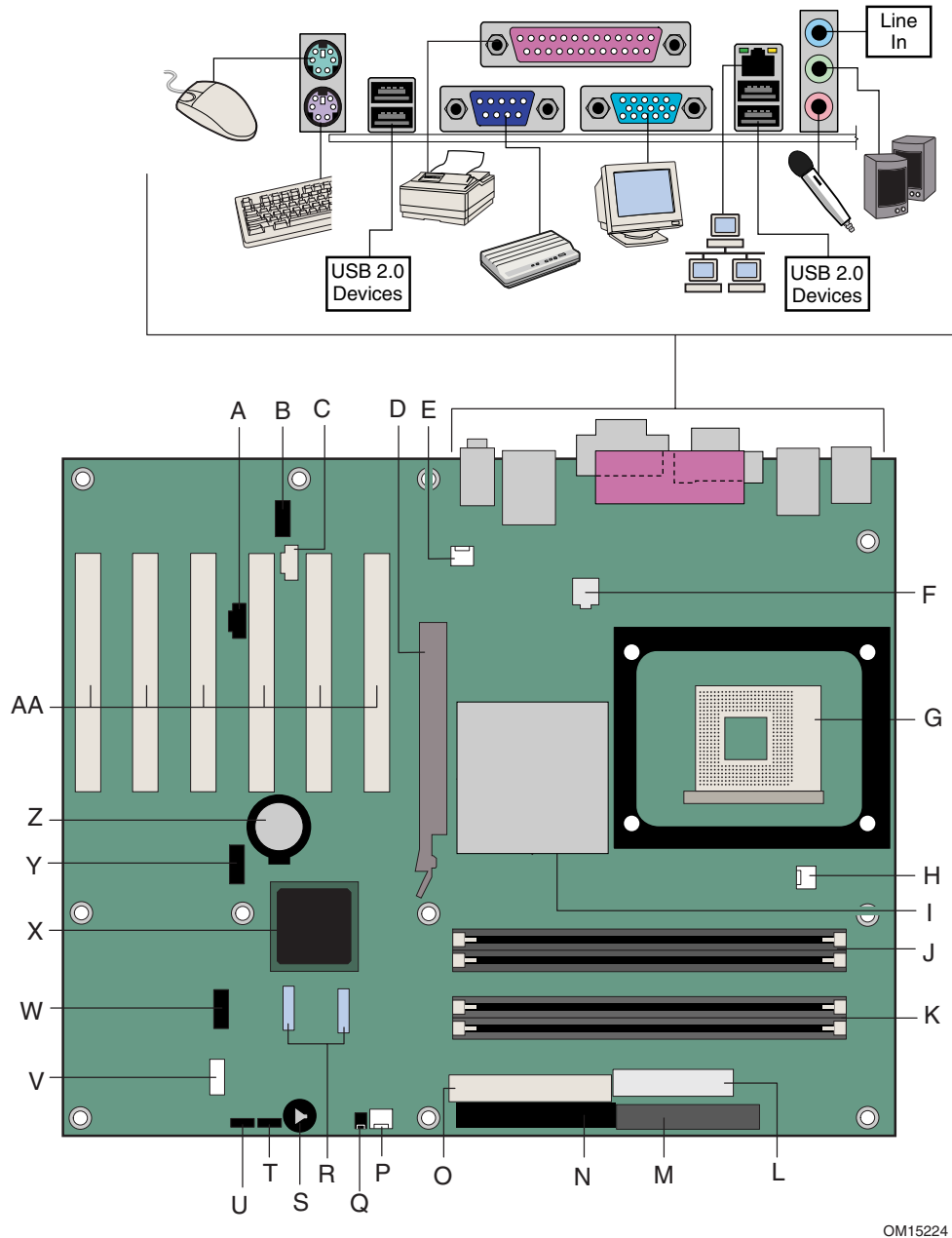

OM15224

Figure 1. Desktop Board D865GBF Components



NOTE

Desktop board D865GLC has three PCI bus add-in card connectors.

Table 4. Desktop Board Components

Label	Description
A	CD-ROM connector (ATAPI-style)
B	Front panel audio header
C	Auxiliary line-in connector (ATAPI-style)
D	AGP connector
E	Rear chassis fan header (fan speed control)
F	12 V processor core voltage connector
G	Processor socket
H	Intel 82865G (GMCH)
I	Processor fan header
J	Channel A DIMM socket
K	Channel B DIMM socket
L	Main power connector
M	Diskette drive connector
N	Primary IDE connector
O	Secondary IDE connector
P	Front chassis fan connector (fan speed control)
Q	Chassis intrusion header
R	Serial ATA connectors
S	Speaker
T	BIOS configuration jumper
U	Alternate power/sleep LED header
V	Front panel header
W	USB 2.0 header
X	Intel 82801EB (ICH5)
Y	USB 2.0 header
Z	Battery
AA	PCI bus add-in card connectors

Related Links:

Go to the following links for the latest information about:

- Intel Desktop Board D865GBF/D865GLC, <http://www.intel.com/design/motherbd>
- processors, <http://support.intel.com/support/motherboards/desktop>
- audio software and utilities, <http://www.intel.com/design/motherbd>
- LAN software and drivers, <http://www.intel.com/design/motherbd>

Processor



CAUTION

Failure to use an ATX12V power supply, or not connecting the 12 V processor core voltage power supply connector to Desktop Board D865GBF/D865GLC may result in damage to the desktop board and/or power supply.

Desktop Board D865GBF/D865GLC supports a single Intel Pentium 4 processor or Intel Celeron processor. Processors are not included with the desktop board and must be purchased separately.

The processor connects to the Intel desktop board through the mPGA478-pin socket. The Intel processors may be removed and replaced to accommodate supported higher speed processors. Desktop Board D865GBF/D865GLC supports the processors listed in Table 5.

Table 5. Supported Processors

Type	Designation (GHz)	FSB Frequency (MHz)	L2 Cache (KB)
Intel® Pentium® 4 processor featuring Hyper-Threading Technology	3, 2.80C, 2.60C, and 2.40C	800	512
	3.06	533	512
Intel Pentium 4 processor	2.8, 2.66, 2.53, 2.4B, and 2.26	533	512
	2.6, 2.5, 2.40, 2.20, 2A, 1.80A, and 1.60A	400	512
Intel® Celeron® processor	2.2, 2.1, and 2.0	400	128

Desktop Board D865GBF/D865GLC requires an ATX12V compliant power supply to function according to desktop board specifications. The board has two ATX12V compliant power supply connectors that are needed to provide extra power to the Intel 865G chipset and Intel processor.

Related Links:

Go to the following link or sections in this manual for more information about:

- the latest information on supported Intel processors for Desktop Board D865GBF/D865GLC <http://support.intel.com/support/motherboards/desktop/>
- instructions on installing or upgrading the processor, page 32 in Chapter 2

Main Memory



NOTE

To be fully compliant with all applicable Intel® SDRAM memory specifications, the board should be populated with DIMMs that support the Serial Presence Detect (SPD) data structure. If your memory modules do not support SPD, you will see a notification to this effect on the screen at power up. The BIOS will attempt to configure the memory controller for normal operation.

The desktop board supports system memory as defined below:

- Dual channel and up to four 184-pin Double Data Rate (DDR) SDRAM Dual Inline Memory Module (DIMMs) connectors with gold-plated contacts.
- Supported memory configurations are:

Memory Speed	Processor	Front Side Bus Frequency	Memory Speed Outcome
DDR400	Pentium 4 processor	800 MHz	400 MHz
DDR333	Pentium 4 processor	800 MHz	320 MHz
	Pentium 4 processor	533 MHz	333 MHz
	Pentium 4 processor or Celeron processor	400 MHz	266 MHz
DDR266	Pentium 4 processor	533 MHz or 400 MHz	266 MHz
	Celeron processor	400 MHz	266 MHz

- Support for:
 - Unbuffered, non-registered DIMMs
 - Serial Presence Detect (SPD) memory only
 - Support for Suspend to RAM (STR), S3 ACPI state
 - Non-ECC DDR (ECC memory will run in non-ECC mode)
 - 2.5 V memory



NOTE

System resources (such as PCI and AGP) require physical memory address locations that reduce available memory addresses above 3 GB. This may result in less than 4 GB of memory being available to the operating system and applications.

Related Links:

Go to the following links or section in this manual for more information about:

- the latest list of tested memory, <http://support.intel.com/support/motherboards/desktop/>
- SDRAM specifications, <http://www.intel.com/technology/memory/pcsdram/spec/>
- installing memory, page 34 in Chapter 2

Intel® 865G Chipset

The Intel 865G chipset consists of the following devices:

- Intel 82865G Graphics and Memory Controller Hub (GMCH) with AHA bus
- Intel 82801EB I/O Controller Hub (ICH5) with AHA bus
- Firmware Hub (FWH)

Related Link:

For more information about Intel 865G chipset, go to:

<http://developer.intel.com/design/nav/pcserver.htm>

Graphics Subsystem

The graphics subsystem features the following:

- Intel 865G chipset
- Intel Extreme Graphics 2
- AGP 8x

Audio Subsystem

The audio subsystem features the following:

- Intel 865G chipset (AC '97)
- Flexible 6-Channel Audio with Jack Sensing
- Analog Devices Inc. AD1985 audio codec

Flexible 6-Channel Audio with Jack Sensing

The Flex 6 audio subsystem includes the following:

- Intel 82801EB I/O Controller Hub (ICH5)
- Analog Devices AD1985 audio codec
- Microphone input that supports a single dynamic, condenser, or electret microphone

The subsystem has the following connectors:

- ATAPI-style CD-ROM connector
- Front panel audio connector, including pins for:
 - Line out
 - Mic in
- Back panel audio connectors that are configurable through the audio devices drivers.
 - Line in or Rear left/right out
 - Line out or Front left/right out
 - Mic in or Center LFE out

Related Links:

Go to the following link or sections in this manual for more information about:

- audio drivers and utilities, <http://support.intel.com/support/motherboards/desktop/>
- installing the front panel audio solution, page 41 in Chapter 2
- setting up the Flexible 6-Channel Audio with Jack Sensing, page 42 in Chapter 2

Input/Output (I/O) Controller

The super I/O controller features the following:

- Low pin count (LPC) interface
- One serial port
- One parallel port with Extended Capabilities Port (ECP) and Enhanced Parallel Port (EPP) support
- Serial IRQ interface compatible with serialized IRQ support for PCI systems
- PS/2-style mouse and keyboard interfaces
- Interface for one 1.2 MB, 1.44 MB, or 2.88 MB diskette drive
- Intelligent power management, including a programmable wake up event interface
- PCI power management support

LAN Subsystem (Optional)

The optional LAN provides a Fast PCI LAN subsystem. The LAN subsystem provides the following functions:

- Basic 10/100 Ethernet LAN (Intel 82562EX) or 10/100/1000 Gigabit Ethernet LAN (Intel 82540EI)
- Support for RJ-45 connector with status indicator LEDs
- Programmable transit threshold
- Configurable EEPROM that contains the MAC address

LAN Subsystem Software

For LAN software and drivers, refer to the D865GLC or D865GBF link on Intel's World Wide Web site at:

<http://support.intel.com/support/motherboards/desktop>

RJ-45 LAN Connector LEDs

Two LEDs are built into the RJ-45 LAN connector. Table 6 describes the LED states when the board is powered up and the 10/100 Ethernet LAN subsystem is operating.

Table 6. RJ-45 10/100 Ethernet LAN Connector LEDs

LED Color	LED State	Indicates
Green	Off	10 Mbit/sec data rate is selected.
	On	100 Mbit/sec data rate is selected.
Yellow	Off	LAN link is not established.
	On (steady state)	LAN link is established.
	On (brighter and pulsing)	The computer is communicating with another computer on the LAN.

Table 7 describes the LED states when the board is powered up and the 10/100/1000 Gigabit Ethernet LAN subsystem is operating.

Table 7. RJ-45 10/100/1000 Gigabit Ethernet LAN Connector LEDs

LED Color	LED State	Indicates
Bi-color LED	Off	10 Mbit/sec data rate is selected.
	Green	100 Mbit/sec data rate is selected.
	Yellow	1 Gbit/sec data rate is selected.
Green	Off	LAN link is not established.
	On (steady state)	LAN link is established.
	On (brighter and pulsing)	The computer is communicating with another computer on the LAN.

Hi-Speed USB 2.0 Support



NOTE

Computer systems that have an unshielded cable attached to a USB port might not meet FCC Class B requirements, even if no device or a low-speed USB device is attached to the cable. Use a shielded cable that meets the requirements for a full-speed USB device.

The desktop board supports up to eight USB 2.0 ports via ICH5; four ports routed to the back panel and four routed to the internal USB 2.0 headers. USB 2.0 ports are backward compatible with USB 1.1 devices. USB 1.1 devices will function normally at USB 1.1 speeds.

USB 2.0 support requires both an operating system and drivers that fully support USB 2.0 transfer rates. Disabling Hi-Speed USB in the BIOS reverts all USB 2.0 ports to USB 1.1 operation. This may be required to accommodate operating systems that do not support USB 2.0.



NOTE

USB devices are limited to USB 1.1 transfer rates prior to operating system and driver initialization.

Enhanced IDE Interface

The ICH5's IDE interface handles the exchange of information between the processor and peripheral devices like hard disks, CD-ROM drives, and Iomega Zip* drives inside the computer. The interface supports:

- Up to four IDE devices (such as hard drives)
- ATAPI-style devices (such as CD-ROM drives)
- Older PIO Mode devices
- Ultra DMA-33 and ATA-66/100 protocols
- Laser Servo (LS-120) drives

Accelerated Graphics Port (AGP)



NOTE

Desktop Board D865GBF/D865GLC is only compatible with 0.8 V and 1.5 V AGP cards.

The AGP connector is keyed for 0.8 V and 1.5 V AGP cards only; the connector is not mechanically compatible with legacy 3.3 V AGP cards. Do not attempt to install a legacy 3.3 V AGP card.

AGP is a high-performance interface for graphics-intensive applications, such as 3D graphics.

AGP is independent of the PCI bus and is intended for exclusive use with graphical display devices.

The AGP 3.0 connector supports 8x, 4x, and 1x AGP cards.

Related Links:

For information about installing the AGP card, see page 37 in Chapter 2.

BIOS

The BIOS provides the Power-On Self-Test (POST), the BIOS Setup program, the PCI and IDE auto-configuration utilities, and the video BIOS. The BIOS is stored in the Firmware Hub.

The BIOS can be updated by following the instructions in Chapter 3 on page 53.

PCI Auto Configuration

If you install a PCI add-in card in your computer, the PCI auto-configuration utility in the BIOS automatically detects and configures the resources (IRQs, DMA channels, and I/O space) for that add-in card. You do not need to run the BIOS Setup program after you install a PCI add-in card.

IDE Auto Configuration

If you install an IDE device (such as a hard drive) in your computer, the IDE auto-configuration utility in the BIOS automatically detects and configures the device for your computer. You do not need to run the BIOS Setup program after installing an IDE device. You can override the auto-configuration options by specifying manual configuration in the BIOS Setup program.

To use ATA-66/100 features, the following items are required:

- An ATA-66/100 peripheral device
- An ATA-66/100 compatible cable
- ATA-66/100 operating system device drivers

Security Passwords

The BIOS includes security features that restrict whether the BIOS Setup program can be accessed and who can boot the computer. A supervisor password and a user password can be set for the Setup and for booting the computer, with the following restrictions:

- The supervisor password gives unrestricted access to view and change all Setup options. If only the supervisor password is set, pressing <Enter> at the password prompt of Setup gives the user restricted access to Setup.
- If both the supervisor and user passwords are set, you must enter either the supervisor password or the user password to access Setup. Setup options are then available for viewing and changing depending on whether the supervisor or user password was entered.
- Setting a user password restricts who can boot the computer. The password prompt is displayed before the computer is booted. If only the supervisor password is set, the computer boots without asking for a password. If both passwords are set, you can enter either password to boot the computer.

Chassis Intrusion

The board supports a chassis security feature that detects if the chassis cover has been removed. The security feature uses a mechanical switch on the chassis that can be connected to the chassis intrusion header on the desktop board. See Figure 15 on page 44 for the location of the chassis intrusion header.

Power Management Features

Power management is implemented at several levels, including:

- Advanced Configuration and Power Interface (ACPI)
- Hardware support:
 - Power connectors
 - Fan connectors
 - Fan Speed Control
 - Suspend to RAM (Instantly Available PC technology)
 - Resume on Ring
 - Wake from USB
 - Wake from PS/2 keyboard/mouse
 - PME# wakeup support

ACPI

ACPI gives the operating system direct control over the power management and Plug & Play functions of a computer. The use of ACPI with the desktop board requires an operating system that provides full ACPI support.

Power Connectors

The desktop board has two power connectors. See Figure 15 on page 44 for the location of the power connectors.

Fan Connectors

The desktop board has two chassis fan connectors (Intel Precision Cooling Technology) and one processor fan connector. See Figure 15 on page 44 for the location of the fan connectors.

Fan Speed Control (Intel® Precision Cooling Technology)

Intel Precision Cooling Technology automatically adjusts the chassis fan speeds depending on the system's temperature. This feature reduces system fan noise by lowering the speed of the chassis fans connected to the front and rear chassis fan connectors. The processor fan connector is not controlled.

The fan speed control feature can be disabled in the BIOS, resulting in the chassis fans always operating at full speed. This feature should be disabled if a self-controlled fan is attached to a chassis fan connector.

Overall system noise reduction will vary based on system configuration and environment.

Suspend to RAM (Instantly Available PC Technology)



CAUTION

For Instantly Available PC technology, the 5 V standby line for the power supply must be capable of delivering adequate +5 V standby current. Failure to provide adequate standby current when using this feature can damage the power supply and/or effect ACPI S3 sleep state functionality.

Instantly Available PC technology enables the board to enter the ACPI S3 (Suspend-to-RAM) sleep state. While in the S3 sleep state, the computer will appear to be off. When signaled by a wake-up device or event, the system quickly returns to its last known awake state.

The desktop board's standby power indicator, shown in Figure 2, is lit when there is standby power to the system. This includes the memory modules and PCI bus connectors, even when the computer appears to be off.

If the system has a dual-colored power LED on the front panel, the sleep state is indicated by the LED turning amber.

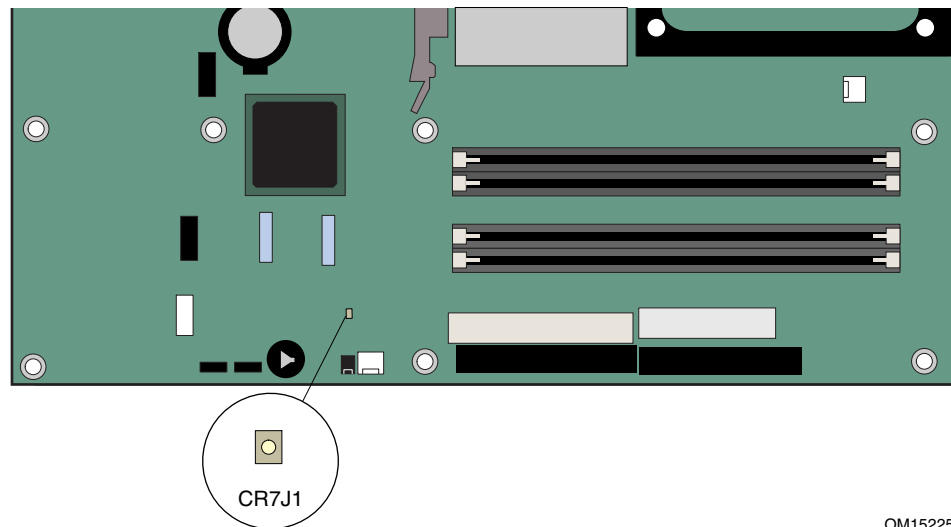

Figure 2. Location of Standby Power Indicator



CAUTION

Power supplies used with this desktop board must be able to provide enough standby current to support the standard Instantly Available (ACPI S3 sleep state) configuration. If the standby current necessary to support multiple wake events from the PCI and/or USB buses exceeds power supply capacity, the desktop board may lose register settings stored in memory.

Related Link:

For more information about standby current requirements for these desktop boards, refer to the TPS by selecting the Technical Documentation link at:

<http://developer.intel.com/design/motherbd/>

Resume on Ring

The operation of Resume on Ring can be summarized as follows:

- Resumes operation from either ACPI S1 or ACPI S3 state
- Requires only one call to access the computer
- Detects incoming call similarly for external and internal modems
- Requires modem interrupt be unmasked for correct operation

Wake from USB

USB bus activity wakes the computer from an ACPI S1 or S3 state.



NOTE

Wake from USB requires the use of a USB peripheral that supports Wake from USB.

Wake from PS/2 Keyboard/Mouse

PS/2 keyboard/mouse activity wakes the computer from an ACPI S1 or S3 state.

PME# Wakeup Support

When the PME# signal on the PCI bus is asserted, the computer wakes from an ACPI S1, S3, or S5 state.

Speaker

A speaker is mounted on the desktop board. The speaker provides audible error code (beep code) information during the Power-On Self-Test (POST).

Battery

The battery on the desktop board keeps the values in CMOS RAM and the clock current when the computer is turned off. See page 48 in Chapter 2 for instructions on how to replace the battery.

Real-Time Clock

The desktop board has a time-of-day clock and 100-year calendar. The battery on the desktop board keeps the clock current when the computer is turned off.

2 Installing and Replacing Desktop Board Components

This chapter tells you how to:

- Install the I/O shield
- Install and remove the desktop board
- Install and remove a processor and memory
- Install and remove an AGP card
- Connect the IDE and Serial ATA cables
- Connect internal headers
- Connecting 6-Channel Flex Audio with Jack Sensing
- Connect hardware control and power cables
- Set the BIOS configuration jumper
- Clear passwords
- Replace the battery

Before You Begin



WARNINGS

The procedures in this chapter assume familiarity with the general terminology associated with personal computers and with the safety practices and regulatory compliance required for using and modifying electronic equipment.

Disconnect the computer from its power source and from any telecommunications links, networks, or modems before performing any of the procedures described in this chapter. Failure to disconnect power, telecommunications links, networks, or modems before you open the computer or perform any procedures can result in personal injury or equipment damage. Some circuitry on the board can continue to operate even though the front panel power button is off.

Follow these guidelines before you begin:

- Always follow the steps in each procedure in the correct order.
- Set up a log to record information about your computer, such as model, serial numbers, installed options, and configuration information.
- Electrostatic discharge (ESD) can damage components. Perform the procedures described in this chapter only at an ESD workstation using an antistatic wrist strap and a conductive foam pad. If such a station is not available, you can provide some ESD protection by wearing an antistatic wrist strap and attaching it to a metal part of the computer chassis.

Installation Precautions

When you install and test the Intel desktop board, observe all warnings and cautions in the installation instructions.

To avoid injury, be careful of:

- Sharp pins on connectors
- Sharp pins on printed circuit assemblies
- Rough edges and sharp corners on the chassis
- Hot components (like processors, voltage regulators, and heat sinks)
- Damage to wires that could cause a short circuit

Observe all warnings and cautions that instruct you to refer computer servicing to qualified technical personnel.

Installation Instructions



CAUTION

Follow these guidelines to meet safety and regulatory requirements when installing this board assembly.

Read and adhere to all of these instructions and the instructions supplied with the chassis and associated modules. If the instructions for the chassis are inconsistent with these instructions or the instructions for associated modules, contact the supplier's technical support to find out how you can ensure that your computer meets safety and regulatory requirements. If you do not follow these instructions and the instructions provided by chassis and module suppliers, you increase safety risk and the possibility of noncompliance with regional laws and regulations.

Ensure Electromagnetic Compatibility (EMC) Compliance

Before computer integration, make sure that the power supply and other modules or peripherals, as applicable, have passed Class B EMC testing and are marked accordingly.

In the installation instructions for the host chassis, power supply, and other modules pay close attention to the following:

- Product certifications or lack of certifications
- External I/O cable shielding and filtering
- Mounting, grounding, and bonding requirements
- Keying connectors when mating the wrong connectors could be hazardous

If the power supply and other modules or peripherals, as applicable, are not Class B EMC compliant before integration, then EMC testing is required on a representative sample of the newly completed computer.

Chassis and Component Certifications

Ensure that the chassis and certain components; such as the power supply, peripheral drives, wiring, and cables; are components certified for the country or market where used. Agency certification marks on the product are proof of certification. Typical product certifications include:

- **In Europe**

The CE marking signifies compliance with all applicable European requirements. If the chassis and other components are not properly CE marked, a supplier's Declaration of Conformity statement to the European EMC directive and Low Voltage directive (as applicable), should be obtained. Additionally, other directives, such as the Radio and Telecommunications Terminal Equipment (R&TTE) directive may also apply depending on product features.

- **In the United States**

A certification mark by a Nationally Recognized Testing Laboratory (NRTL) such as UL, CSA, or ETL signifies compliance with safety requirements. Wiring and cables must also be UL listed or recognized and suitable for the intended use. The FCC Class B logo for home or office use signifies compliance with electromagnetic interference (EMI) requirements.

- **In Canada**

A nationally recognized certification mark such as CSA or cUL signifies compliance with safety requirements. The Industry Canada statement at the front of this product guide demonstrates compliance with Canadian EMC regulations. Industry Canada recognizes and accepts FCC certification as denoting compliance with national electromagnetic interference (emissions) requirements.

Prevent Power Supply Overload

Do not overload the power supply output. To avoid overloading the power supply, make sure that the calculated total current loads of all the modules within the computer is less than the output current rating of each of the power supplies output circuits.

Place Battery Marking

There is insufficient space on this desktop board to provide instructions for replacing and disposing of the Lithium ion coin cell battery. For system safety certification, the following statement or equivalent statement is required to be permanently and legibly marked on the chassis near the battery.



CAUTION

Risk of explosion if the battery is replaced with an incorrect type. Batteries should be recycled where possible. Disposal of used batteries must be in accordance with local environmental regulations.

Use Only for Intended Applications

All Intel desktop boards are evaluated as Information Technology Equipment (I.T.E.) for use in personal computers for installation in homes, offices, schools, computer rooms, and similar locations. The suitability of this product for other applications or environments, such as medical, industrial, alarm systems, test equipment, etc. may require further evaluation.

Related Links:

For information about regulatory compliance, go to Appendix B on page 95.

Installing the I/O Shield

The desktop board comes with an I/O shield. When installed in the chassis, the shield blocks radio frequency transmissions, protects internal components from dust and foreign objects, and promotes correct airflow within the chassis.

Install the I/O shield before installing the desktop board in the chassis. Place the shield inside the chassis as shown in Figure 3. Press the shield into place so that it fits tightly and securely. If the shield doesn't fit, obtain a properly-sized shield from the chassis supplier.

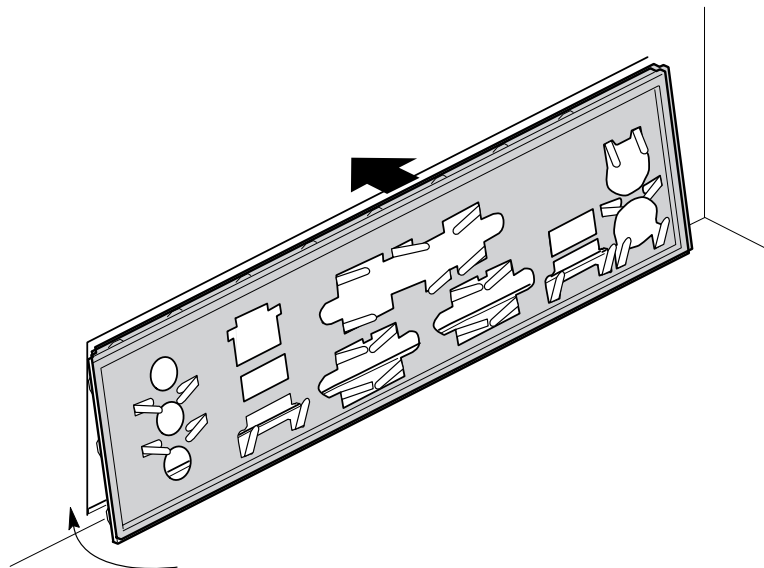

OM15226

Figure 3. Installing the I/O Shield

Installing and Removing the Desktop Board

WARNING

Only qualified technical personnel should do this procedure. Disconnect the computer from its power source before performing the procedures described here. Failure to disconnect the power before you open the computer can result in personal injury or equipment damage.



NOTE

Refer to Appendix B for regulatory requirements.

Refer to your chassis manual for instructions on installing and removing the desktop board.

Figure 4 shows the location of the 11 mounting holes for Desktop Board D865GBF. Desktop Board D865GLC has eight mounting holes.

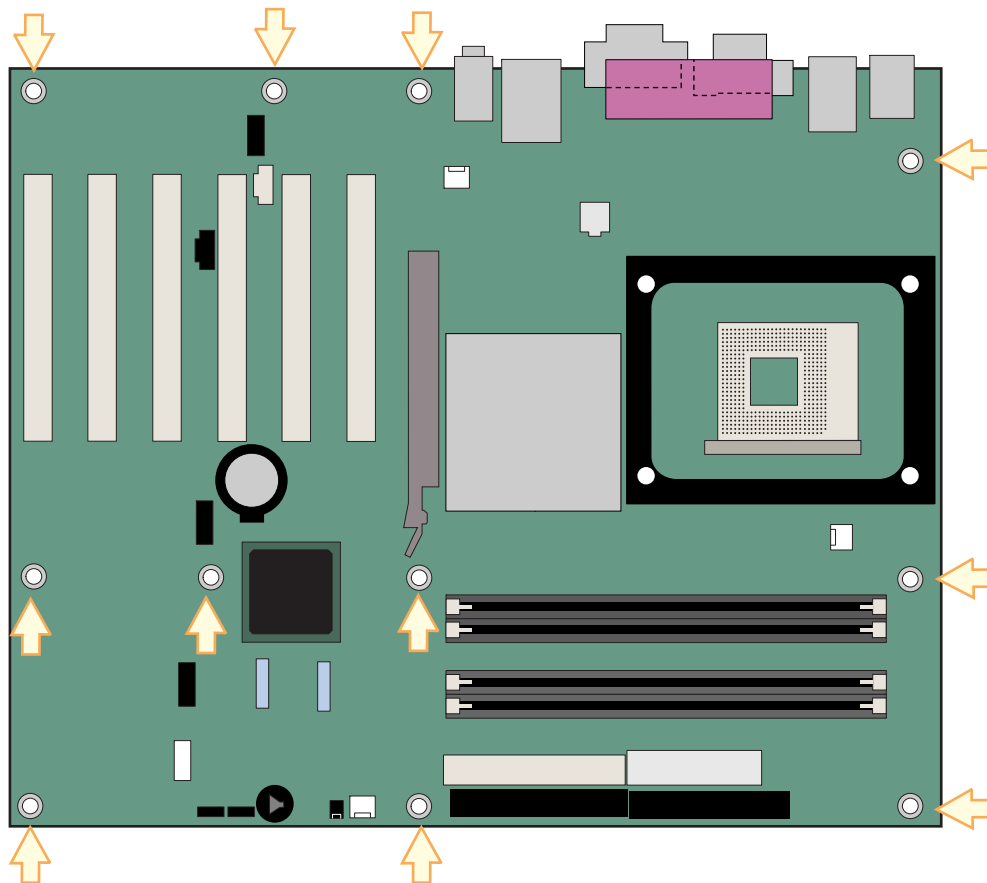

OM15227

Figure 4. Location of Desktop Board Mounting Screw Holes

Installing and Removing a Processor

Instructions on how to install the processor to the desktop board are given below.

Installing a Processor



CAUTION

Before installing or removing the processor, make sure that AC power has been removed by unplugging the power cord from the computer; the standby power LED should not be lit (see Figure 2 on page 24). Failure to do so could damage the processor and the board.

To install a processor, follow these instructions:

1. Observe the precautions in “Before You Begin” on page 27.
2. Locate the processor socket and raise the socket lever completely.
3. Install the processor so that the corner with the triangle marking (A) is aligned with the corner where the lever is attached to the socket (see Figure 5).
4. Lower the lever to its original position.

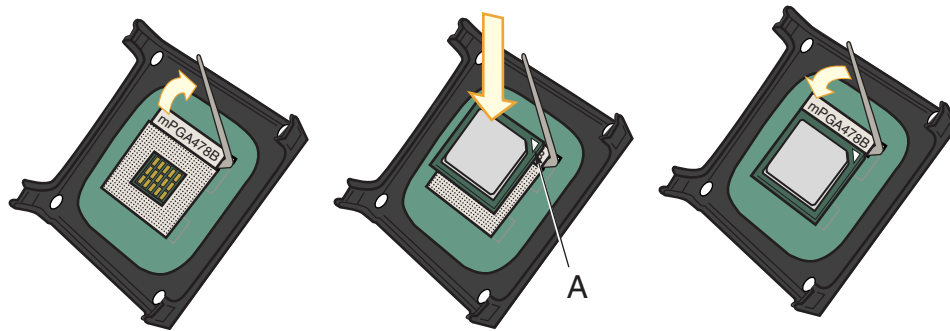

OM15028

Figure 5. Installing a Processor

Installing the Processor Fan Heat Sink

Desktop Board D865GBF/D865GLC has an integrated processor fan heat sink retention mechanism (RM). For instructions on how to install the processor fan heat sink to the integrated processor fan heat sink RM, refer to the boxed processor manual or the Intel World Wide Web site at:

<http://support.intel.com/support/processors/pentium4/intnotes478.htm>

Connecting the Processor Fan Heat Sink Cable

Connect the processor fan heat sink cable to the processor fan connector (see Figure 6).

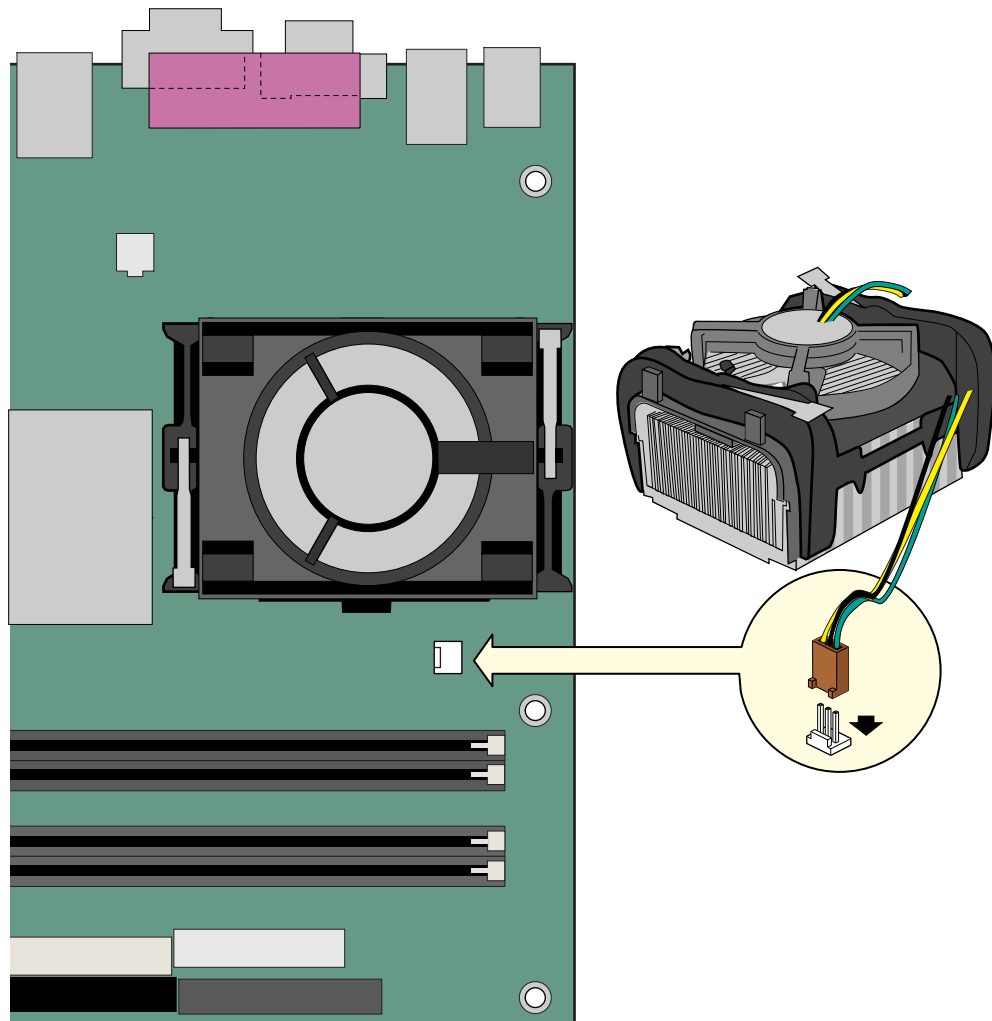

OM15229

Figure 6. Connecting the Processor Fan Heat Sink Cable to the Processor Fan Connector

Removing the Processor

For instruction on how to remove the processor fan heat sink and processor, refer to the processor installation manual or the Intel World Wide Web site at:

<http://support.intel.com/support/processors/pentium4/intnotes478.htm>

Installing and Removing Memory



CAUTION

To be fully compliant with all applicable Intel SDRAM memory specifications, the boards require DIMMs that support the Serial Presence Detect (SPD) data structure. You can access the PC Serial Presence Detect Specification at:

<http://www.intel.com/technology/memory/pcsdram/spec/>

Desktop Board D865GBF/D865GLC has four dual channel 184-pin DIMM sockets arranged as DIMM 0 and DIMM 1 in both Channel A and Channel B, as shown in Figure 7 (color was added to the DIMM sockets to show how to match DIMMs for dual channel configuration).

Refer to the “Main Memory” section on page 17 for memory requirements.

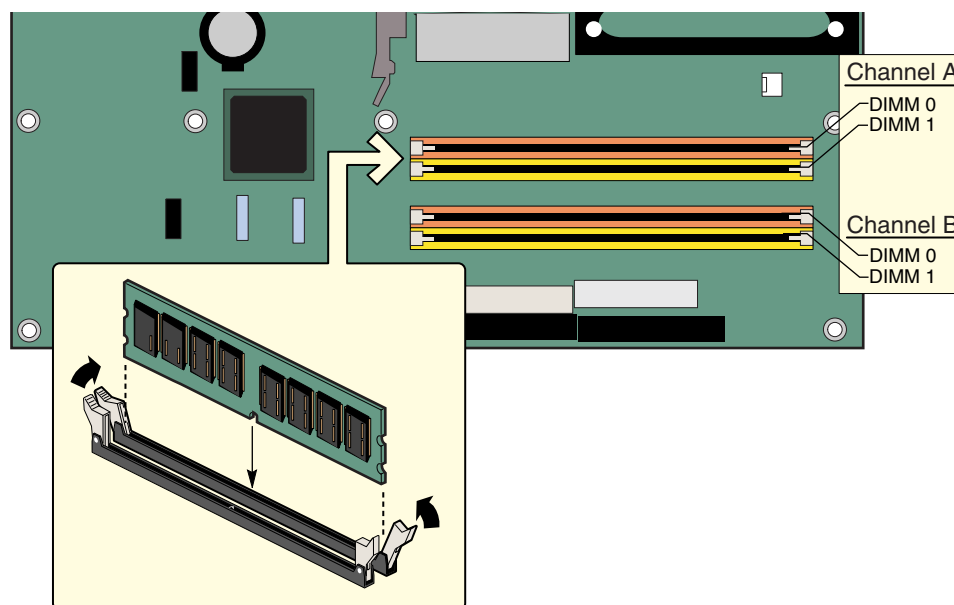

OM15230

Figure 7. Installing a Memory Module

Installing DIMMs

Before installing DIMMs, read and follow these guidelines for dual channel configuration.



NOTE

Performance Acceleration Technology (PAT) requires a processor with 800 MHz FSB frequency and DDR400 memory.

Install a matched pair of DIMMs equal in speed, size, and technology (see Figure 8) in DIMM 0 in both channels A and B.

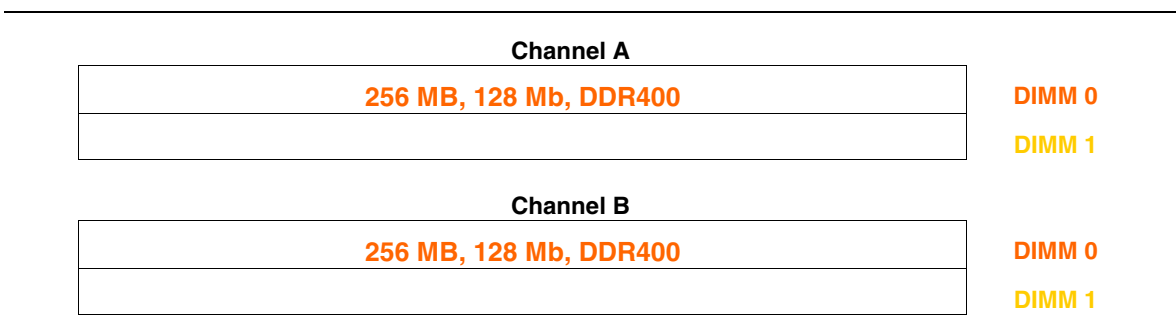

Figure 8. Dual Configuration Example with Two DIMMs

If additional memory is to be used, then install another matched pair of DIMMs in DIMM 1 in both channels A and B (see Figure 9).

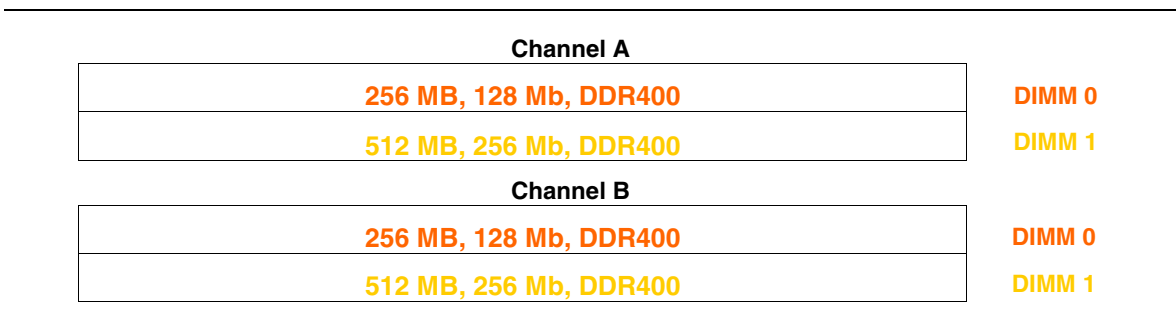

Figure 9. Dual Configuration Example with Four DIMMs



NOTE

All other memory configurations will result in single channel memory operation.



CAUTION

Install memory in the DIMM sockets prior to installing an AGP video card to avoid interference with the memory retention mechanism.

To install DIMMs, follow these steps:

1. Observe the precautions in “Before You Begin” on page 27.
2. Turn off all peripheral devices connected to the computer. Turn off the computer and disconnect the AC power cord.
3. Remove the computer’s cover and locate the DIMM sockets (see Figure 7).
4. Remove the AGP video card if it interferes with the DIMM clips from being easily opened and closed.
5. Make sure the clips at either end of the DIMM socket(s) are pushed outward to the open position.
6. Holding the DIMM by the edges, remove it from its anti-static package.
7. Position the DIMM above the socket. Align the small notch in the bottom edge of the DIMM with the key in the socket (see inset in Figure 7).
8. Insert the bottom edge of the DIMM into the socket.
9. When the DIMM is inserted, push down on the top edge of the DIMM until the retaining clips snap into place. Make sure the clips are firmly in place.
10. Reinstall the AGP card if it was removed prior to installing the DIMMs.
11. Replace the computer’s cover and reconnect the AC power cord.

Removing DIMMs

To remove a memory module, follow these steps:

1. Observe the precautions in “Before You Begin” on page 27.
2. Turn off all peripheral devices connected to the computer. Turn off the computer.
3. Remove the AC power cord from the computer.
4. Remove the computer’s cover.
5. Remove the AGP card if it interferes with the DIMM clips from being easily opened and closed.
6. Gently spread the retaining clips at each end of the DIMM socket. The DIMM pops out of the socket.
7. Hold the DIMM by the edges, lift it away from the socket, and store it in an anti-static package.
8. Reinstall the AGP card if you removed it before taking out the DIMMs.
9. Reinstall and reconnect any parts you removed or disconnected to reach the DIMM sockets.
10. Replace the computer’s cover and reconnect the AC power cord.

Installing and Removing an AGP Card



CAUTION

When installing any AGP card in the desktop board, ensure that it is fully seated in the AGP connector before you power on the system. If the card is not fully seated in the AGP connector, an electrical short may result across the AGP connector pins. Depending on the over-current protection of the power supply, certain board components and/or traces may be damaged.

The AGP connector supports 0.8 V (4x and 1x) and 1.5 V (8x) AGP cards. The desktop board has an integrated AGP card retention mechanism (RM).

Installing an AGP Card

Follow these instructions to install an AGP card:

1. Observe the precautions in “Before You Begin” on page 27.
2. Place the card in the AGP connector.
3. Press down on the card until it is completely seated in the AGP connector and the card retention notch snaps into place around the RM pin.
4. Secure the card’s metal bracket to the chassis back panel with a screw.

Removing the AGP Card

Follow these instructions to remove the AGP card from the RM (see Figure 10):

1. Observe the precautions in “Before You Begin” on page 27.
2. Remove the screw (B) that secures the card’s metal bracket (A) to the chassis back panel.
3. Push back on the RM lever (C), as shown in Figure 10, until the retention pin completely clears the notch in the card.
4. Pull the card straight up (D).

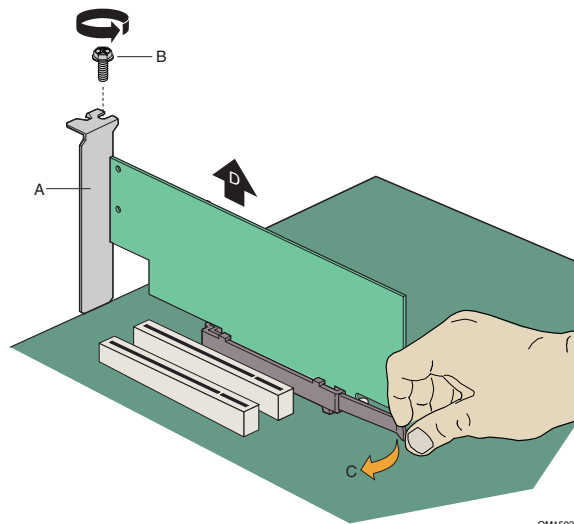

OM15031

Figure 10. Removing the AGP Card

Connecting the IDE Cable

The two IDE cables support the Ultra DMA-33 and ATA-66/100 transfer protocols. Each of the cables can connect two drives to the desktop board. Figure 11 shows the correct installation of the cable.



NOTE

ATA-66/100 compatible cables are backward compatible with drives using slower IDE transfer protocols. If an ATA-66/100 disk drive and a disk drive using any other IDE transfer protocol are attached to the same cable, the maximum transfer rate between the drives may be reduced to that of the slowest drive.



NOTE

Do not connect an ATA device as a slave on the same IDE cable as an ATAPI master device. For example, do not connect an ATA hard drive as a slave to an ATAPI CD-ROM drive.

For correct function of the cable:

- Observe the precautions in “Before You Begin” on page 27.
- Attach the cable end with the single connector to the Intel desktop board (A).
- Attach the cable end with the two closely spaced connectors to the drives (B).

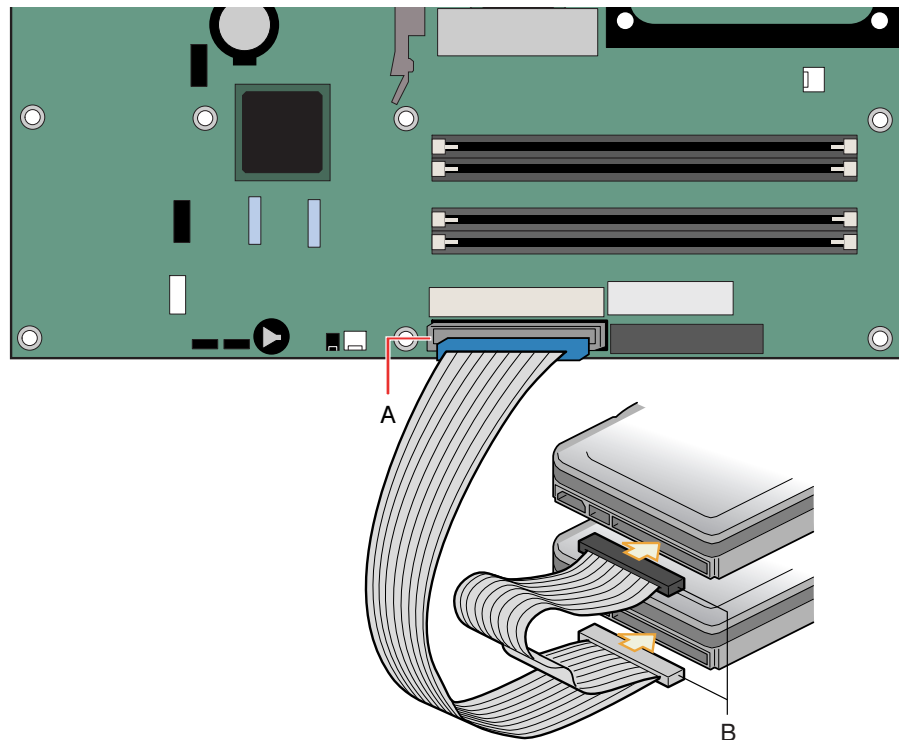

OM15232

Figure 11. Connecting the IDE Cable

Connecting the Serial ATA Cable

The SATA cable (4-conductor) supports the Serial ATA protocol and connects a single drive to the desktop board. Either end of the cable can be connected to the SATA drive or the connector on the board (see Figure 12).

For correct cable function:

1. Observe the precaution in “Before You Begin” on page 23.
2. Attach either cable end to the connector (A) on the board.
3. Attach either cable end to the connector (B) on the drive.

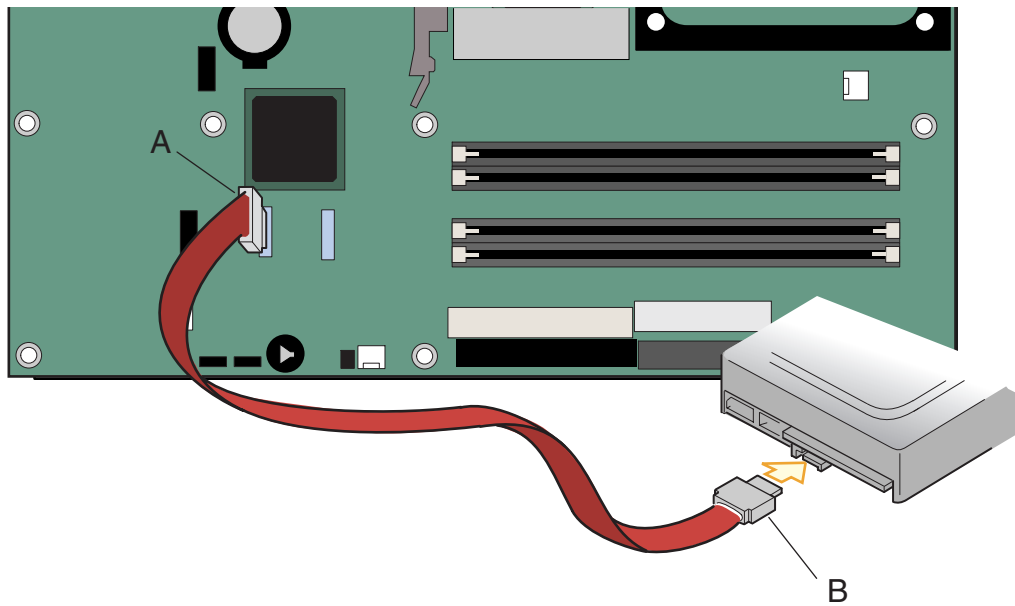

OM15467

Figure 12. Connecting the Serial ATA Cable

Connecting Internal Headers

Figure 13 shows the location of internal headers.

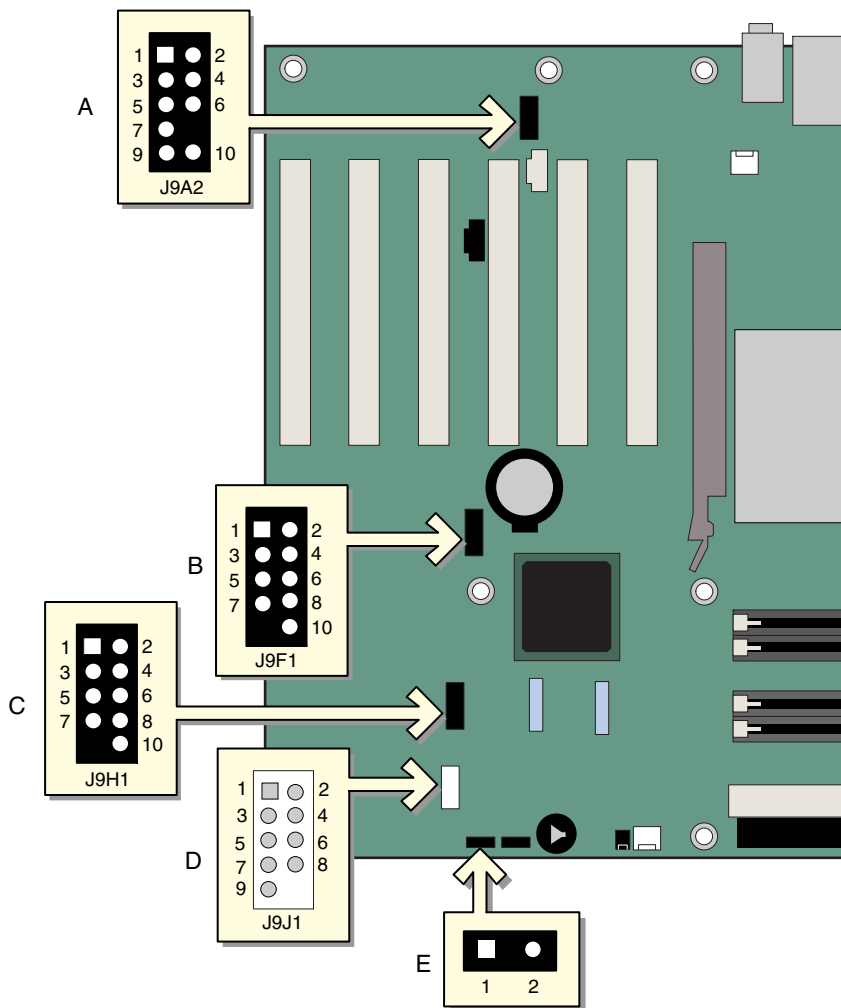

OM15240

Item	Description
A	Front panel audio
B	USB 2.0
C	USB 2.0
D	Front panel
E	Power LED

Figure 13. Internal Headers

Installing a Front Panel Audio Solution

Figure 13-A shows the location of the front panel audio header. Table 8 shows the pin assignments for the front panel audio header.

Table 8. Front Panel Audio Header Signal Names (J9A2)

Pin	Signal Name	Pin	Signal Name
1	AUD-MIC	2	AUD-GND
3	AUD-MIC-BIAS	4	AUD-VCC
5	AUD-FPOUT-R	6	AUD-RET-R
7	HP-ON	8	KEY
9	AUD-FPOUT-L	10	AUD-RET-L

To install the cable that connects the front panel audio solution to the front panel audio header, follow these steps:

1. Observe the precautions in “Before You Begin” on page 27.
2. Turn off all peripheral devices connected to the computer. Turn off the computer and disconnect the AC power cord.
3. Remove the cover.
4. Locate the front panel audio header. Remove the two jumpers from the header to disable the back panel audio connectors.
5. Install a correctly keyed and shielded front panel audio cable.
6. Connect the audio cable to the front panel audio solution.
7. Replace the cover.

To restore back panel operations, follow these steps:

1. Observe the precautions in “Before You Begin” on page 27.
2. Turn off all peripheral devices connected to the computer. Turn off the computer and disconnect the AC power cord.
3. Remove the cover.
4. Remove the front panel audio cable.
5. Install a jumper on pins 5-6 (rear R channel).
6. Install a jumper on pins 9-10 (rear L channel).
7. Replace the cover.

Setting up the Flexible 6-Channel Audio with Jack Sensing

After installing the SoundMAX 4 XL audio driver from the Intel Express Installer CD-ROM, the multi-channel audio feature can now be enabled. See Figure 14 for back panel audio connectors.

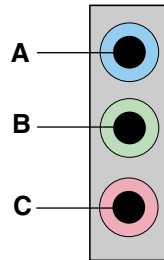

OM15694

Item	Description
A	Rear left/right out or Line In
B	Front left/right out or S/PDIF line out
C	Center-LFE (Subwoofer) or Mic In

Figure 14. Back Panel Audio Connectors for 6-Channel Audio with Jack Sensing

Multi-Channel Analog Audio

Connect two speakers to the front left/right out (B) and two speakers to the rear left/right out (A) for both 4- and 6-channel audio configurations. For 6-channel audio, connect two additional speakers to the center-LFE (C).

Multi-Channel Digital Audio

To take advantage of the S/PDIF functionality, a 1/8-inch stereo phone plug to the RCA jack adapter/splitter is required to convert from the stereo input to RCA connection. Connect the stereo input side of the adapter to the S/PDIF (B) connector, and connect the speaker system or S/PDIF decoder to the RCA jack left channel (white, if colored).

Related Link:

For the location of the ATAPI-style audio headers, go to page 87 in Chapter 5.

Connecting USB 2.0 Headers

Before connecting USB 2.0 headers, observe the precautions in “Before You Begin” on page 27. Figure 13-A and -B on page 40 shows the location of the USB 2.0 headers. Table 9 shows the pin assignments for the headers.

Table 9. USB 2.0 Headers (J9F1 and J9H1)

USB Port A		USB Port B	
Pin	Signal Name	Pin	Signal Name
1	Power	2	Power
3	D-	4	D-
5	D+	6	D+
7	Ground	8	Ground
9	Key (no pin)	10	Not connected

Note: USB ports may be assigned as needed.

Connecting the Front Panel Header

Before connecting the front panel header, observe the precautions in “Before You Begin” on page 27. Figure 13-C on page 40 shows the location of the front panel header. Table 10 shows the pin assignments for the front panel header.

Table 10. Front Panel Header (J9J1)

Pin	Signal	In/Out	Description	Pin	Signal	In/Out	Description
Hard Drive Activity LED				Power LED			
1	HD_PWR	Out	Hard disk LED pull-up (330 Ω) to +5 V	2	HDR_BLNK_GRN	Out	Front panel green LED
3	HDA#	Out	Hard disk active LED	4	HDR_BLNK_YEL	Out	Front panel yellow LED
Reset Switch				On/Off Switch			
5	Ground		Ground	6	SWITCH_ON#	In	Power switch
7	FP_RESET#	In	Reset switch	8	Ground		Ground
9	+5 V	Out	Power	10	N/C		Not connected

Connecting Hardware Control and Power Cables

Figure 15 shows the location of the chassis intrusion and fan headers, and power connectors.

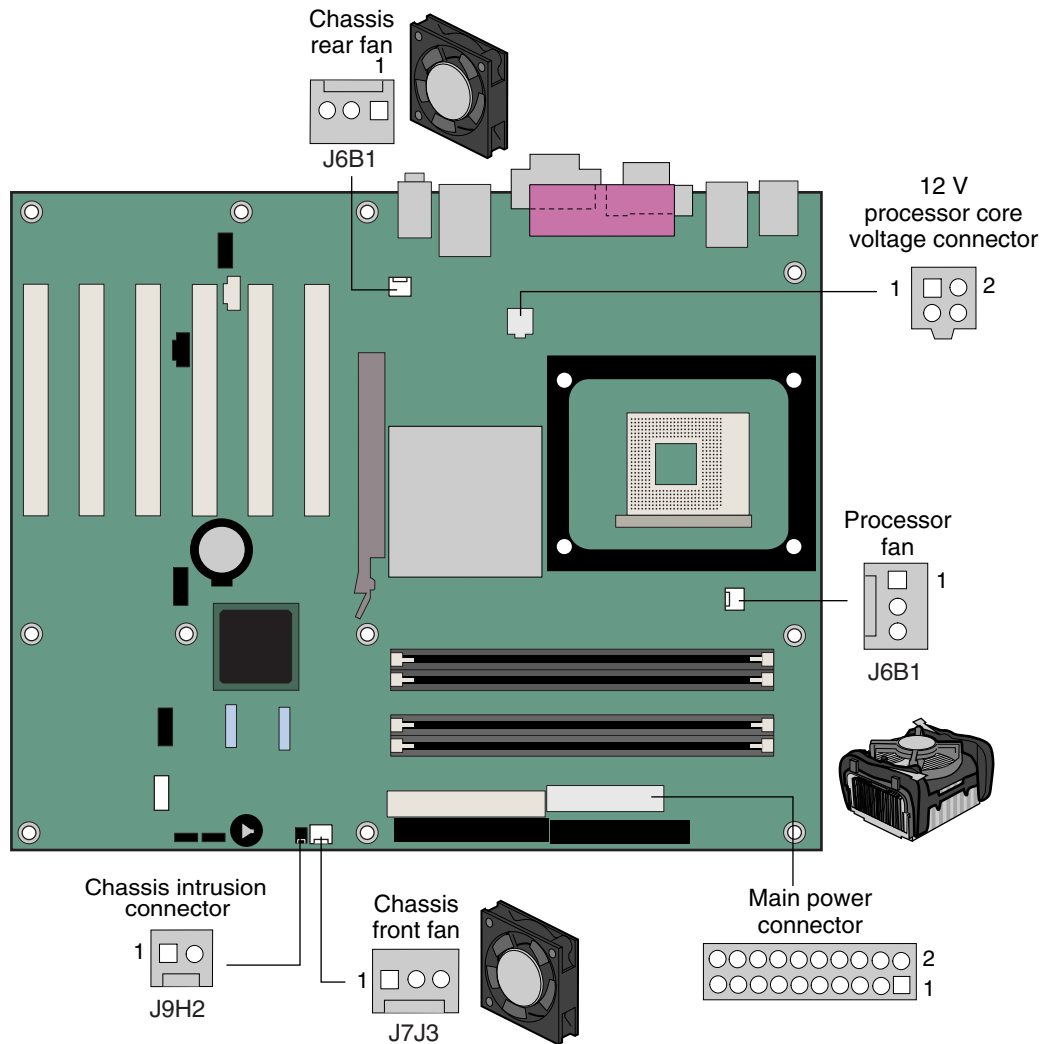

OM15237

Figure 15. Location of Hardware Control Headers and Power Connectors

Connecting the Chassis Intrusion Cable

Connect the chassis intrusion cable to the header shown in Figure 15.

Connecting Fans

Connect the processor's fan heat sink cable to the processor fan header on the board. Connect chassis fan cables to the board fan headers. See Figure 15 for fan header locations.

Connecting Power Cables



CAUTION

Failure to use an ATX12V power supply, or not connecting the 12 V processor core voltage power supply connector to the desktop board may result in damage to the desktop board and/or power supply.

Figure 15 shows the location of power connectors.

1. Observe the precautions in “Before You Begin” on page 27.
2. Connect the 12 V processor core voltage power supply cable to the 2x2 connector.
3. Connect the main power cable to the 2x10 connector.

Setting the BIOS Configuration Jumper Block

CAUTION

Always turn off the power and unplug the power cord from the computer before changing the jumper. Moving the jumper with the power on may result in unreliable computer operation.

The location of the desktop board's BIOS configuration jumper is shown in Figure 16.

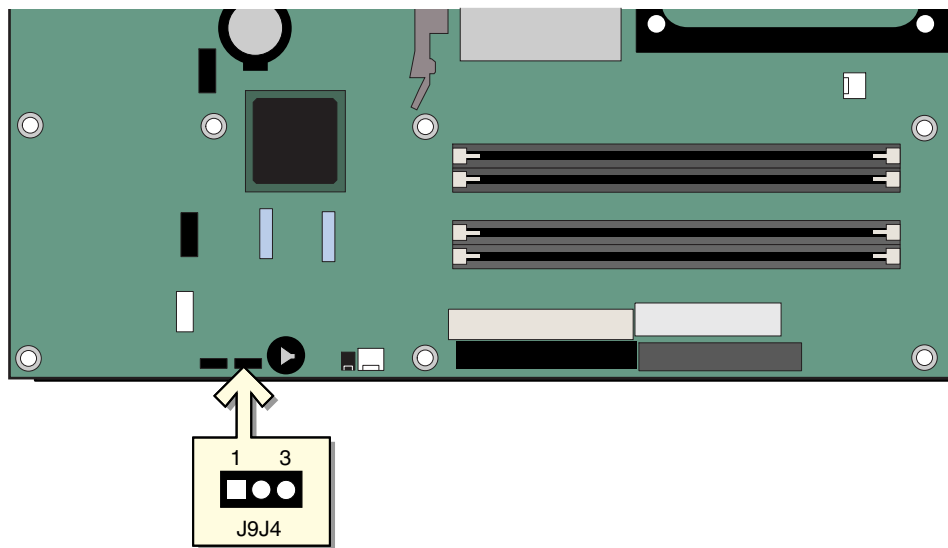

OM15233

Figure 16. Location of the BIOS Configuration Jumper Block

The three-pin BIOS jumper block enables all board configurations to be done in BIOS Setup. Table 11 shows the jumper settings for the Setup program modes.

Table 11. Jumper Settings for the BIOS Setup Program Modes (J9J4)

Jumper Setting	Mode	Description
	Normal (default) (1-2)	The BIOS uses the current configuration and passwords for booting.
	Configure (2-3)	After the Power-On Self-Test (POST) runs, the BIOS displays the Maintenance Menu. Use this menu to clear passwords.
	Recovery (None)	The BIOS recovers data from a recovery diskette in the event of a failed BIOS update.

Clearing Passwords

This procedure assumes that the board is installed in the computer and the configuration jumper block is set to normal mode.

1. Observe the precautions in “Before You Begin” on page 27.
2. Turn off all peripheral devices connected to the computer. Turn off the computer. Disconnect the computer’s power cord from the AC power source (wall outlet or power adapter).
3. Remove the computer cover.
4. Find the configuration jumper block (see Figure 16).
5. Place the jumper on pins 2-3 as shown below.



6. Replace the cover, plug in the computer, turn on the computer, and allow it to boot.
7. The computer starts the Setup program. Setup displays the Maintenance menu.
8. Use the arrow keys to select Clear Passwords. Press <Enter> and Setup displays a pop-up screen requesting that you confirm clearing the password. Select Yes and press <Enter>. Setup displays the maintenance menu again.
9. Press <F10> to save the current values and exit Setup.
10. Turn off the computer. Disconnect the computer’s power cord from the AC power source.
11. Remove the computer cover.
12. To restore normal operation, place the jumper on pins 1-2 as shown below.



13. Replace the cover, plug in the computer, and turn on the computer.

Replacing the Battery

A coin-cell battery (CR2032) powers the real-time clock and CMOS memory. When the computer is not plugged into a wall socket, the battery has an estimated life of three years. When the computer is plugged in, the standby current from the power supply extends the life of the battery. The clock is accurate to ± 13 minutes/year at 25 °C with 3.3 VSB applied.

When the voltage drops below a certain level, the BIOS Setup program settings stored in CMOS RAM (for example, the date and time) might not be accurate. Replace the battery with an equivalent one. Figure 17 on page 51 shows the location of the battery.



CAUTION

Risk of explosion if the battery is replaced with an incorrect type. Batteries should be recycled where possible. Disposal of used batteries must be in accordance with local environmental regulations.



PRECAUTION

Risque d'explosion si la pile usagée est remplacée par une pile de type incorrect. Les piles usagées doivent être recyclées dans la mesure du possible. La mise au rebut des piles usagées doit respecter les réglementations locales en vigueur en matière de protection de l'environnement.



FORHOLDSREGEL

Eksplosionsfare, hvis batteriet erstattes med et batteri af en forkert type. Batterier bør om muligt genbruges. Bortskaffelse af brugte batterier bør foregå i overensstemmelse med gældende miljølovgivning.



OBS!

Det kan oppstå eksplosjonsfare hvis batteriet skiftes ut med feil type. Brukte batterier bør kastes i henhold til gjeldende miljølovgivning.



VIKTIGT!

Risk för explosion om batteriet ersätts med felaktig batterityp. Batterier ska kasseras enligt de lokala miljövårdsbestämmelserna.



VARO

Räjähdyksvaara, jos pariston tyyppi on väärä. Paristot on kierrätettävä, jos se on mahdollista. Käytetyt paristot on hävitettävä paikallisten ympäristömääräysten mukaisesti.



VORSICHT

Bei falschem Einsetzen einer neuen Batterie besteht Explosionsgefahr. Die Batterie darf nur durch denselben oder einen entsprechenden, vom Hersteller empfohlenen Batterietyp ersetzt werden. Entsorgen Sie verbrauchte Batterien den Anweisungen des Herstellers entsprechend.

**AVVERTIMENTO**

Esiste il pericolo di un esplosione se la pila non viene sostituita in modo corretto. Utilizzare solo pile uguali o di tipo equivalente a quelle consigliate dal produttore. Per disfarsi delle pile usate, seguire le istruzioni del produttore.

**PRECAUCIÓN**

Existe peligro de explosión si la pila no se cambia de forma adecuada. Utilice solamente pilas iguales o del mismo tipo que las recomendadas por el fabricante del equipo. Para deshacerse de las pilas usadas, siga igualmente las instrucciones del fabricante.

**WAARSCHUWING**

Er bestaat ontploffingsgevaar als de batterij wordt vervangen door een onjuist type batterij. Batterijen moeten zoveel mogelijk worden gerecycled. Houd u bij het weggooien van gebruikte batterijen aan de plaatselijke milieuwetgeving.

**ATENÇÃO**

Haverá risco de explosão se a bateria for substituída por um tipo de bateria incorreto. As baterias devem ser recicladas nos locais apropriados. A eliminação de baterias usadas deve ser feita de acordo com as regulamentações ambientais da região.

**AŠCIAROŽZNAŚĆ**

Існуе рызыка выбуху, калі заменены акумулятар непраўльнага тыпу. Акумулятары павінны, па магчымасці, перепрацоўвацца. Пазбаўляцца ад старых акумулятараў патрэбна згодна з мясцовымі заканадаўствам па экалогіі.

**UPOZORNĚNÍ**

V případě výměny baterie za nesprávný druh může dojít k výbuchu. Je-li to možné, baterie by měly být recyklovány. Baterie je třeba zlikvidovat v souladu s místními předpisy o životním prostředí.

**Προσοχή**

Υπάρχει κίνδυνος για έκρηξη σε περίπτωση που η μπαταρία αντικατασταθεί από μία λανθασμένου τύπου. Οι μπαταρίες θα πρέπει να ανακυκλώνονται όταν κάτι τέτοιο είναι δυνατό. Η απόρριψη των χρησιμοποιημένων μπαταριών πρέπει να γίνεται σύμφωνα με τους κατά τόπο περιβαλλοντικούς κανονισμούς.

**VIGYÁZAT**

Ha a telepet nem a megfelelő típusú telepre cseréli, az felrobbanhat. A telepeket lehetőség szerint újra kell hasznosítani. A használt telepeket a helyi környezetvédelmi előírásoknak megfelelően kell kiselejtezni.

**注意**

異なる種類の電池を使用すると、爆発の危険があります。リサイクルが可能な地域であれば、電池をリサイクルしてください。使用後の電池を破棄する際には、地域の環境規制に従ってください。



AWAS

Risiko letupan wujud jika bateri digantikan dengan jenis yang tidak betul. Bateri sepatutnya dikitar semula jika boleh. Pelupusan bateri terpakai mestilah mematuhi peraturan alam sekitar tempatan.



OSTRZEŻENIE

Istnieje niebezpieczeństwo wybuchu w przypadku zastosowania niewłaściwego typu baterii. Zużyte baterie należy w miarę możliwości utylizować zgodnie z odpowiednimi przepisami ochrony środowiska.



PRECAUȚIE

Risc de explozie, dacă bateria este înlocuită cu un tip de baterie necorespunzător. Bateriile trebuie reciclate, dacă este posibil. Depozitarea bateriilor uzate trebuie să respecte reglementările locale privind protecția mediului.



ВНИМАНИЕ

При использовании батареи несоответствующего типа существует риск ее взрыва. Батареи должны быть утилизированы по возможности. Утилизация батарей должна проводиться по правилам, соответствующим местным требованиям.



UPOZORNENIE

Ak batériu vymeníte za nesprávny typ, hrozí nebezpečenstvo jej výbuchu. Batérie by sa mali podľa možnosti vždy recyklovať. Likvidácia použitých batérií sa musí vykonávať v súlade s miestnymi predpismi na ochranu životného prostredia.



POZOR

Zamenjava baterije z baterijo drugačnega tipa lahko povzroči eksplozijo. Če je mogoče, baterije reciklirajte. Rabljene baterije zavržite v skladu z lokalnimi okoljevarstvenimi predpisi.



การระวัง

ระวังการระเบิดที่เกิดจากเปลี่ยนแบตเตอรี่ผิดประเภท หากเป็นไปได้ ควรนำแบตเตอรี่ไปรีไซเคิล การทิ้งแบตเตอรี่ใช้แล้วต้องเป็นไปตามกฎข้อบังคับด้านสิ่งแวดล้อมของท้องถิ่น.



UYARI

Yanlış türde batarya takıldığında patlama riski vardır. Bataryalar mümkün olduğunda geri dönüştürülmelidir. Kullanılmış piller, yerel çevre yasalarına uygun olarak atılmalıdır.



ОСТОРОГА

Використовуйте батареї правильного типу, інакше існують ризик вибуху. Якщо можливо, використані батареї слід утилізувати. Утилізація використаних батарей має бути виконана згідно місцевих норм, що регулюють охорону довкілля.

To replace the battery, follow these steps:

1. Observe the precautions in “Before You Begin” (see page 27).
2. Turn off all peripheral devices connected to the computer. Disconnect the computer’s power cord from the AC power source (wall outlet or power adapter).
3. Remove the computer cover.
4. Locate the battery on the board (see Figure 17).
5. With a medium flat-bladed screwdriver, gently pry the battery free from its connector. Note the orientation of the “+” and “-” on the battery.
6. Install the new battery in the connector, orienting the “+” and “-” correctly.
7. Replace the computer cover.

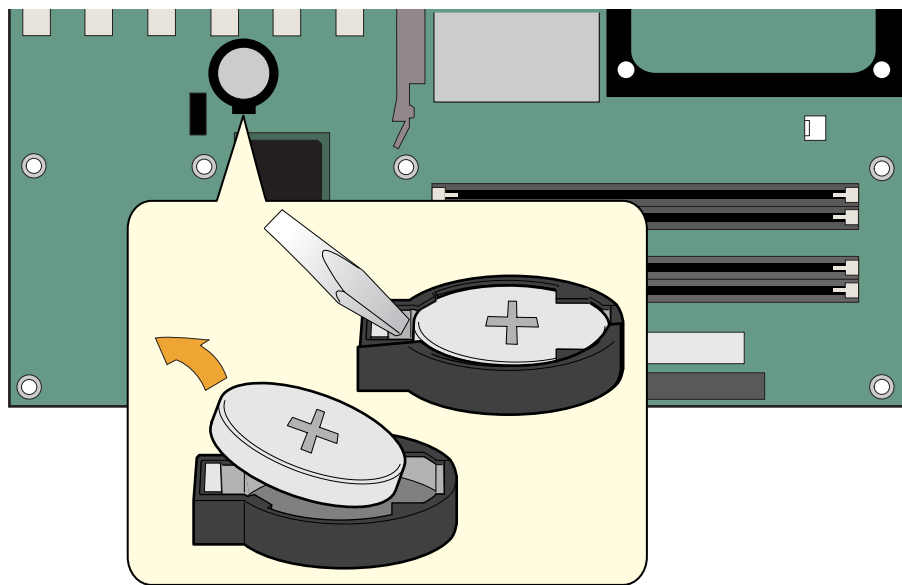

OM15234

Figure 17. Removing the Battery

3 Updating the BIOS

This chapter tells you how to update the BIOS by either using the Intel® Express BIOS Update utility or the Iflash Memory Update utility, and how to recover the BIOS if an update fails.

Updating the BIOS with the Intel® Express BIOS Update Utility

With the Intel Express BIOS Update utility you can update the system BIOS while in the Windows environment. The BIOS file is included in an automated update utility that combines the functionality of the Intel® Flash Memory Update Utility and the ease-of use of Windows-based installation wizards.

To update the BIOS with the Intel Express BIOS Update utility:

1. Go to the Intel World Wide Web site:
<http://support.intel.com/support/motherboards/desktop/>
2. Navigate to the Desktop Board D865GBF or D865GLC page and click the Express BIOS Update utility file for the Desktop Board D865GBF/D865GLC BIOS.
3. Download the file to your hard drive. (You can also save this file to a diskette. This is useful if you are updating the BIOS for multiple identical systems.)
4. Close all other applications. This step is required. Your system will be rebooted at the last Express BIOS Update window.
5. Double-click the executable file from the location on your hard drive where it was saved. This runs the update program.
6. Follow the instructions provided in the dialog boxes to complete the BIOS update.

Updating the BIOS with the Iflash Memory Update Utility

With the Iflash Memory Update utility you can update the system BIOS from a floppy disk or other bootable media. The utility available from the Web provides a simple method for creating a bootable flash memory update floppy that will automatically update your BIOS.

Obtaining the BIOS Update File

You can update to a new version of the BIOS by using the BIOS update file. The BIOS update file is a compressed self-extracting archive that contains all the files you need to update the BIOS. The BIOS update file contains:

- New BIOS files
- BIOS recovery files
- Iflash Memory Update utility

You can obtain the BIOS update file through your computer supplier or by navigating to the Desktop Board D865GBF or D865GLC page on the Intel World Wide Web site:

<http://support.intel.com/support/motherboards/desktop>



NOTE

Review the instructions distributed with the update utility before attempting a BIOS update.

The Intel Flash Memory Update Utility allows you to:

- Update the BIOS in flash memory
- Update the language section of the BIOS

Updating the BIOS



CAUTION

The AUTOEXEC.BAT file provided with the update files updates the BIOS. Do not interrupt the process or the system may not function.

1. Boot the computer with the BIOS update diskette in drive A. During system boot, the AUTOEXEC.BAT file provided with the update files will automatically run the BIOS update process.
2. When the update process is complete, the monitor will display a message telling you to remove the diskette and to reboot the system.
3. As the computer boots, check the BIOS identifier (version number) to make sure the update was successful. If a logo appears, press <Esc> to view the POST messages.

Recovering the BIOS

It is unlikely that anything will interrupt the BIOS update; however, if an interruption occurs, the BIOS could be damaged. The following steps explain how to recover the BIOS if an update fails. The following procedure uses recovery mode for the Setup program. See page 46 for more information on Setup modes.



NOTE

Because of the small amount of code available in the boot block area, there is no video support. You will not see anything on the screen during this procedure. Monitor the procedure by listening to the speaker and looking at the diskette drive LED.

1. Turn off the computer, disconnect the computer's power cord, and disconnect all external peripherals.
2. Remove the computer cover and locate the configuration jumper block (see Figure 16).
3. Remove the jumper from all pins as shown below to set recovery mode for Setup.
4. Insert the bootable BIOS update diskette into diskette drive A.
5. Replace the computer cover, connect the power cord, turn on the computer, and allow it to boot. The recovery process will take a few minutes.
6. Listen to the speaker:
 - Upon applying power, drive A will begin to show activity. In about a minute, two beeps are heard and drive A activity ceases (temporarily) indicating the successful recovery of the BIOS core. Drive A activity will begin again followed by two more beeps indicating the successful recovery of the boot block. This sequence of events indicates a successful BIOS recovery.
 - A series of continuous beeps indicates a failed BIOS recovery.
7. If recovery fails, return to step 1 and repeat the recovery process.
8. If recovery is successful, turn off the computer, and disconnect its power cord.
9. Remove the computer cover and continue with the following steps.
10. On the jumper block, reinstall the jumper back on pins 1-2 as shown below to set normal mode for Setup.



11. Leave the update diskette in drive A, replace the computer cover, and connect the computer's power cord.
12. Turn on the computer and continue with the BIOS update.

4 Using the BIOS Setup Program

The BIOS Setup program can be used to view and change the BIOS settings for the computer. The BIOS Setup program is accessed by pressing the <F2> key after the Power-On Self-Test (POST) memory test begins and before the operating system boot begins.



NOTE

The BIOS Setup menus described in this section may not show the latest settings. For the latest BIOS settings, refer to the Intel® Desktop Board D865GBF/D865GLC Technical Product Specification or the Intel World Wide Web site:

<http://support.intel.com/support/motherboards/desktop>



NOTE

For reference purposes, you should write down the current Setup settings. When you make changes to the settings, update this record.



NOTE

The Setup menus described in this section apply to the desktop boards with BIOS identifier BF86510A.86A. Boards with other BIOS identifiers might have differences in some of the Setup menu screens.

Table 12 shows the BIOS Setup program menu bar.

Table 12. BIOS Setup Program Menu Bar

Maintenance	Main	Advanced	Security	Power	Boot	Exit		
Clears passwords and Boot Integrity Service (BIS)* credentials, and configures extended configuration memory settings	Allocates resources for hardware components	Configures advanced features available through the chipset	Sets passwords and security features	Configures power management features	Selects boot options and power supply controls	Saves or discards changes to set program options		

* For information about the BIS, refer to the Intel Web site at:

<http://developer.intel.com/design/security/index1.htm>

Table 13 shows the function keys available for menu screens.

Table 13. BIOS Setup Program Function Keys

BIOS Setup Program Function Key	Description
<<-> or <->>	Selects a different menu screen
<↑> or <↓>	Moves cursor up or down
<Tab>	Moves cursor to the next field
<Enter>	Executes command or selects the submenu
<F9>	Load the default configuration values for the current menu
<F10>	Save the current values and exits the BIOS Setup program
<Esc>	Exits the menu

Maintenance Menu

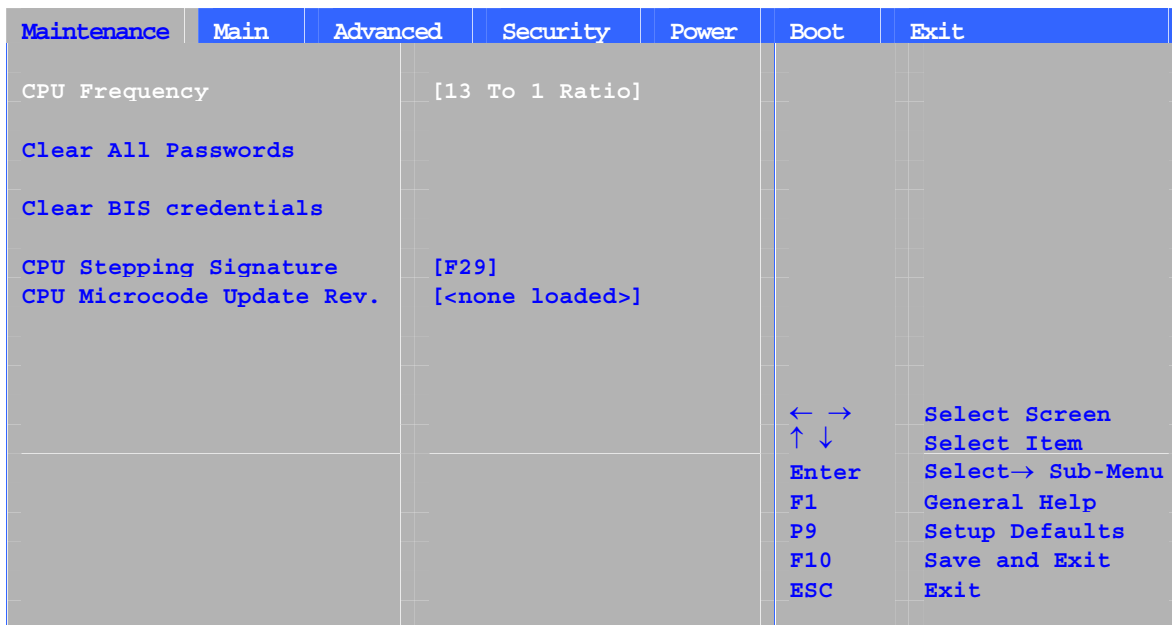

The menu shown in Table 14 is used to clear the Setup passwords. Setup only displays this menu in configure mode. See page 46 for information about setting configure mode.

Table 14. Maintenance Menu

Feature	Options	Description
CPU Frequency	No options	
Clear All Passwords	<ul style="list-style-type: none"> • Ok • Cancel 	Clears both the user and supervisor passwords.
Clear BIS Credentials	<ul style="list-style-type: none"> • Ok • Cancel 	Clears the Wired for Management Boot Integrity Service (BIS) credentials.
CPU Stepping Signature	No options	Displays processor's Stepping Signature.
CPU Microcode Update Revision	No options	Displays processor's Microcode Update Revision.

* For information about the BIS, refer to the Intel Web site at:

<http://developer.intel.com/design/security/index1.htm>

Main Menu

Main	Advanced	Security	Power	Boot	Exit
BIOS Version	xxxxx10A.86A.xxxx.xxx				
Processor Type	Intel(R) Pentium(R) 4				
Hyper-Threading Technology	[Enabled]				
Processor Speed	X.XX GHz				
System Bus Speed	XXX MHz				
System Memory Speed	XXX MHz				
Cache RAM	XXX KB				
Total Memory	XXX MB				
Memory Mode	Dual Channel				
Memory Channel A Slot 0	XXX MB (DDRYYY)				
Memory Channel A Slot 1	Not Installed				
Memory Channel B Slot 0	XXX MB (DDRYYY)				
Memory Channel B Slot 1	Not Installed				
Language	[English]				
System Time	[xx.xx.xx]				
				← →	Select Screen
				↑ ↓	Select Item
				Enter	Select ► Sub-Menu
				F1	General Help
				P9	Setup Defaults
				F10	Save and Exit
				ESC	Exit

Table 15 describes the Main Menu. This menu reports processor and memory information and is used to configure the system date and system time.

Table 15. Main Menu

Feature	Options	Description
BIOS Version	No options	Displays the version of the BIOS.
Processor Type	No options	Displays processor type.
Hyper-Threading Technology	<ul style="list-style-type: none"> • Enabled (default) • Disabled 	Enables or disables Hyper-Threading Technology.
Processor Speed	No options	Displays processor speed.
System Bus Speed	No options	Displays the system bus speed.
System Memory Speed	No options	Displays the system memory speed.
Cache RAM	No options	Displays the size of second-level cache and whether it is ECC-capable.
Total Memory	No options	Displays the total amount of RAM.
Memory Mode	No options	Displays the amount and type of RAM in the memory banks.
Language	<ul style="list-style-type: none"> • English (default) • Français 	Selects the current default language used by the BIOS.
System Time	Hour, minute, and second	Specifies the current time.

Advanced Menu

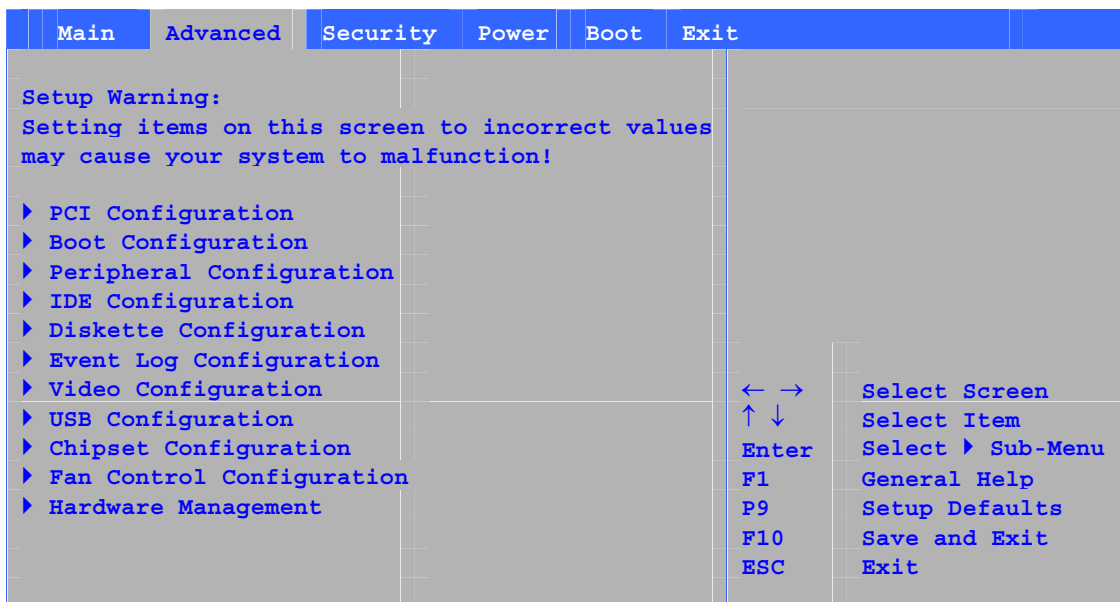
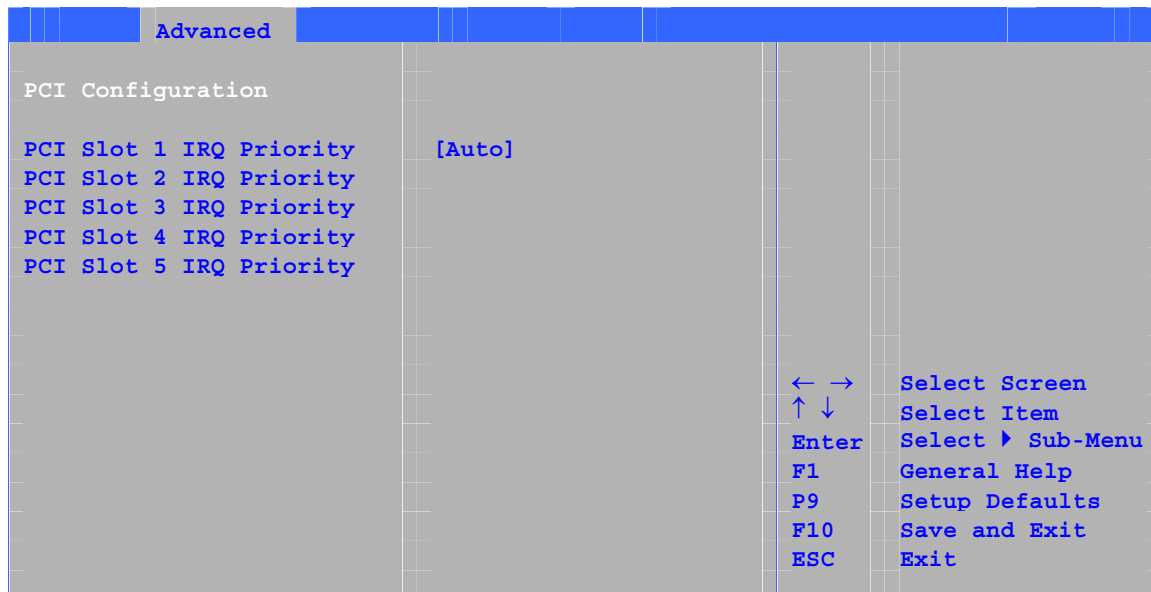

Table 16 describes the Advanced Menu. This menu is used to set advanced features that are available through the chipset.

Table 16. Advanced Menu

Feature	Options	Description
PCI Configuration	No options	Configures individual PCI slot's IRQ priority. When selected, displays the PCI Configuration submenu.
Boot Configuration	No options	Configures Plug & Play and the Numlock key, and resets configuration data. When selected, displays the Boot Configuration submenu.
Peripheral Configuration	No options	Configures peripheral ports and devices. When selected, displays the Peripheral Configuration submenu.
IDE Configuration	No options	Specifies type of connected IDE device.
Diskette Configuration	No options	Configures the floppy drive(s). When selected, displays the Diskette Configuration submenu.
Event Log Configuration	No options	Configures event logging. When selected, displays the Event Log Configuration submenu.
Video Configuration	No options	Configures video features. When selected, displays the Video Configuration submenu.
USB Configuration	No options	Configures USB features. When selected, displays the USB Configuration submenu.
Chipset Configuration	No options	Configures chipset features. When selected, displays the Chipset Configuration submenu.
Fan Control Configuration	No options	Configures fan control features. When selected, displays the Fan Control Configuration submenu.
Hardware Management	No options	Configures hardware management. When selected, displays the Hardware Management submenu.

PCI Configuration Submenu



The submenu shown in Table 17 is used to configure the IRQ priority of PCI slots individually.

Table 17. PCI Configuration Submenu

Feature	Options	Description
PCI Slot 1 IRQ Priority PCI Slot 2 IRQ Priority PCI Slot 3 IRQ Priority PCI Slot 4 IRQ Priority PCI Slot 5 IRQ Priority	<ul style="list-style-type: none"> • Auto (default) • 3 • 5 • 9 • 10 • 11 	Allows selection of IRQ priority.

Boot Configuration Submenu

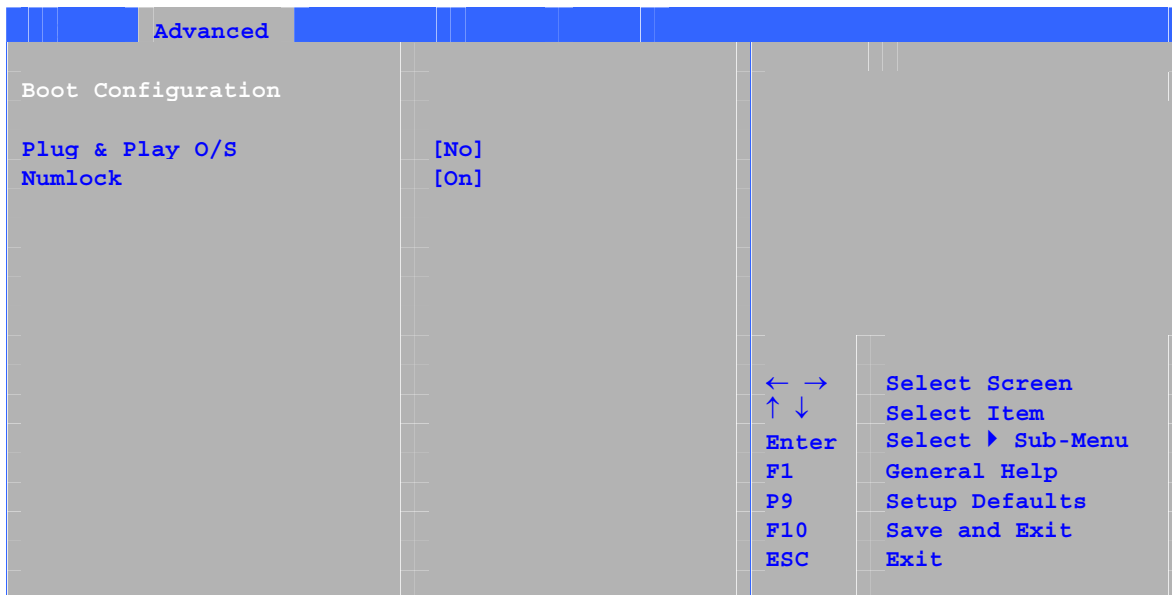

The submenu shown in Table 18 is used to set the Plug & Play options and the power-on state of the Numlock key.

Table 18. Boot Configuration Submenu

Feature	Options	Description
Plug & Play O/S	<ul style="list-style-type: none"> • No (default) • Yes 	<p>Specifies if manual configuration is desired.</p> <p><i>No</i> lets the BIOS configure all devices in the system. This setting is appropriate when using a Plug and Play operating system.</p> <p><i>Yes</i> lets the operating system configure Plug & Play (PnP) devices not required for boot if your system has a Plug & Play operating system. This option is available for use during lab testing.</p>
Numlock	<ul style="list-style-type: none"> • Off • On (default) 	<p>Specifies the power-on state of the Numlock feature on the numeric keypad of the keyboard.</p>

Peripheral Configuration Submenu

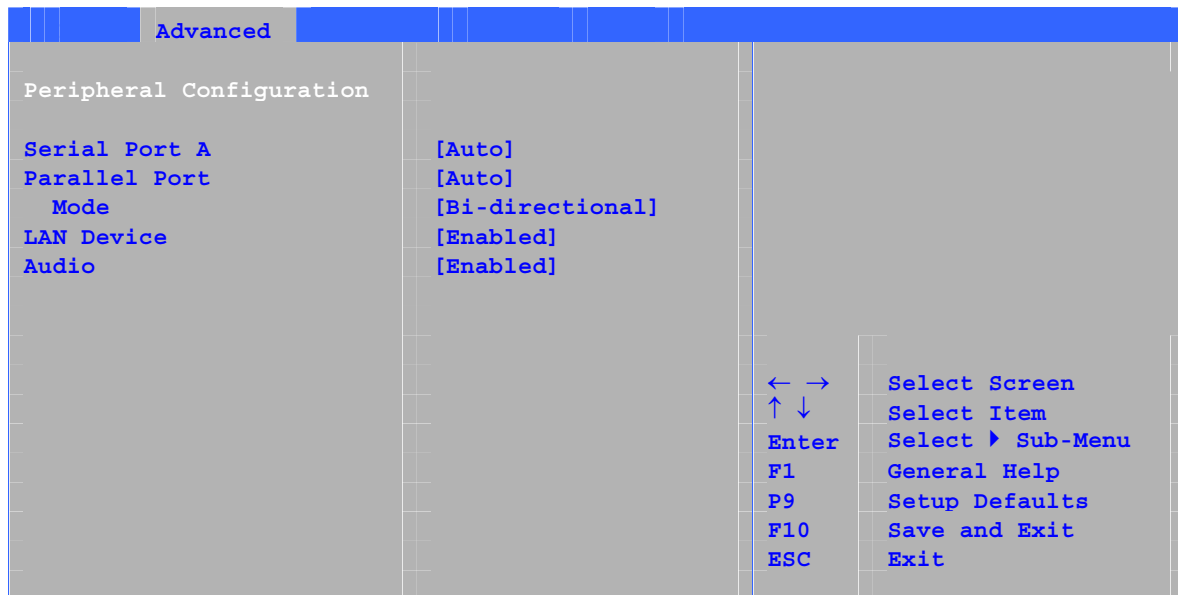

This submenu shown in Table 19 is used for configuring computer peripherals.

Table 19. Peripheral Configuration Submenu

Feature	Options	Description
Serial Port A	<ul style="list-style-type: none"> Disabled Enabled Auto (default) 	Configures serial port A. <i>Auto</i> assigns the first free COM port, normally COM1, the address 3F8h, and the interrupt IRQ4. An * (asterisk) displayed next to an address indicates a conflict with another device.
Base I/O Address (This feature is present only when Serial Port A is set to <i>Enabled</i>)	<ul style="list-style-type: none"> 3F8 (default) 2F8 3E8 2E8 	Specifies the base I/O address for serial port A, if serial port A is Enabled.
Interrupt (This feature is present only when Serial Port A is set to <i>Enabled</i>)	<ul style="list-style-type: none"> IRQ 3 IRQ 4 (default) 	Specifies the interrupt for serial port A, if serial port A is Enabled.
Parallel Port	<ul style="list-style-type: none"> Disabled Enabled Auto (default) 	Configures the parallel port. <i>Auto</i> assigns LPT1 the address 378h and the interrupt IRQ7. An * (asterisk) displayed next to an address indicates a conflict with another device.

continued

Table 19. Peripheral Configuration Submenu (continued)

Feature	Options	Description
Mode	<ul style="list-style-type: none"> • Output only • Bi-directional (default) • EPP • ECP 	<p>Selects the mode for the parallel port. Not available if the parallel port is disabled.</p> <p><i>Output Only</i> operates in AT*-compatible mode.</p> <p><i>Bi-directional</i> operates in PS/2-compatible mode.</p> <p><i>EPP</i> is Extended Parallel Port mode, a high-speed bi-directional mode.</p> <p><i>ECP</i> is Enhanced Capabilities Port mode, a high-speed bi-directional mode.</p>
Base I/O Address (This feature is present only when Parallel Port is set to <i>Enabled</i>)	<ul style="list-style-type: none"> • 378 (default) • 278 	Specifies the base I/O address for the parallel port, if Parallel Port is Enabled.
Interrupt (This feature is present only when Parallel Port is set to <i>Enabled</i>)	<ul style="list-style-type: none"> • IRQ 5 • IRQ 7 (default) 	Specifies the interrupt for the parallel port, if Parallel Port is Enabled.
LAN Device (This feature is present only when there is onboard LAN)	<ul style="list-style-type: none"> • Disabled • Enabled (default) 	Enables or disables the LAN device.
Audio	<ul style="list-style-type: none"> • Disabled • Enabled (default) 	Enables or disables onboard audio.

ATA/IDE Configuration Submenu

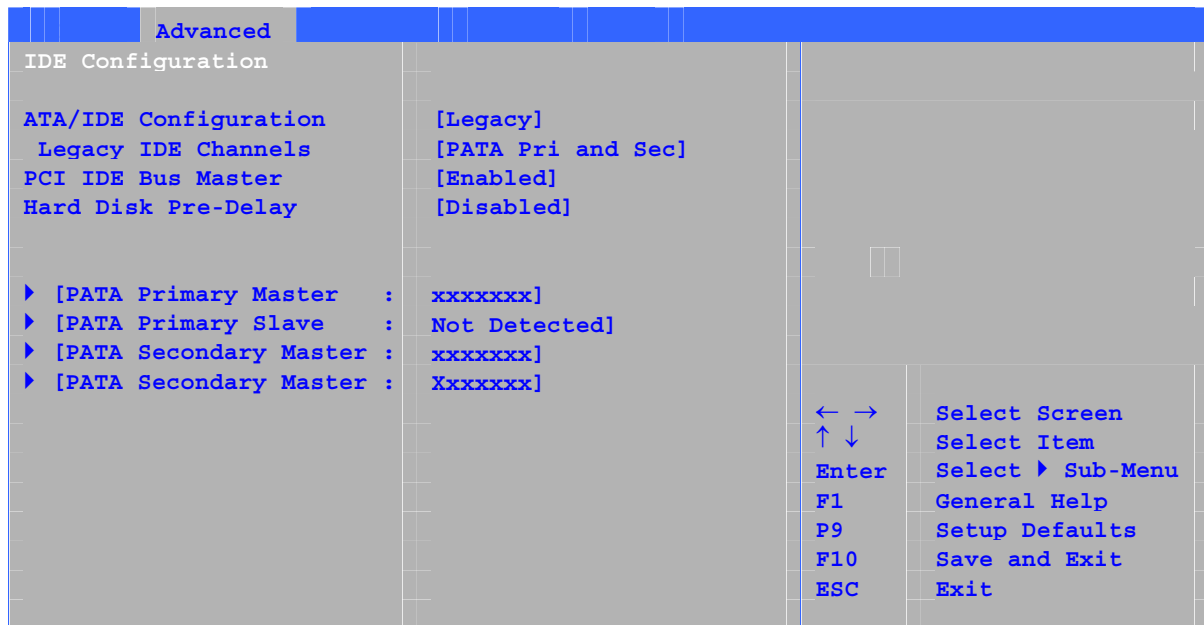

This submenu shown in Table 20 is used to configure IDE device options.

Table 20. ATA/IDE Configuration Submenu

Feature	Options	Description
ATA/IDE Configuration	<ul style="list-style-type: none"> Disabled Legacy Enhanced (default) 	Specifies the integrated IDE controller. <i>Disabled</i> disables the integrated IDE controller. <i>Legacy</i> enables up to two IDE channels for OS requiring legacy IDE operation. <i>Enhanced</i> all SATA and PATA resources
Legacy IDE Channels	<ul style="list-style-type: none"> PATA Pri only PATA Sec only PATA PRI and Sec (default) SATA P0/P1 only SATA P0/P1, PATA Sec SATA P0/P1, PATA Pri 	Configures PATA and SATA resources for OS requiring legacy IDE operation.
PCI IDE Bus Master	<ul style="list-style-type: none"> Disabled Enabled (default) 	Allows a PCI device to initiate a transaction as a master.
Hard Disk Pre-Delay	<ul style="list-style-type: none"> Disabled (default) 3 Seconds 6 Seconds 9 Seconds 12 Seconds 15 Seconds 21 Seconds 30 Seconds 	Specifies the hard disk drive pre-delay. Causes the BIOS to insert a delay before attempting to detect IDE drives in the system.

PATA and SATA Submenus

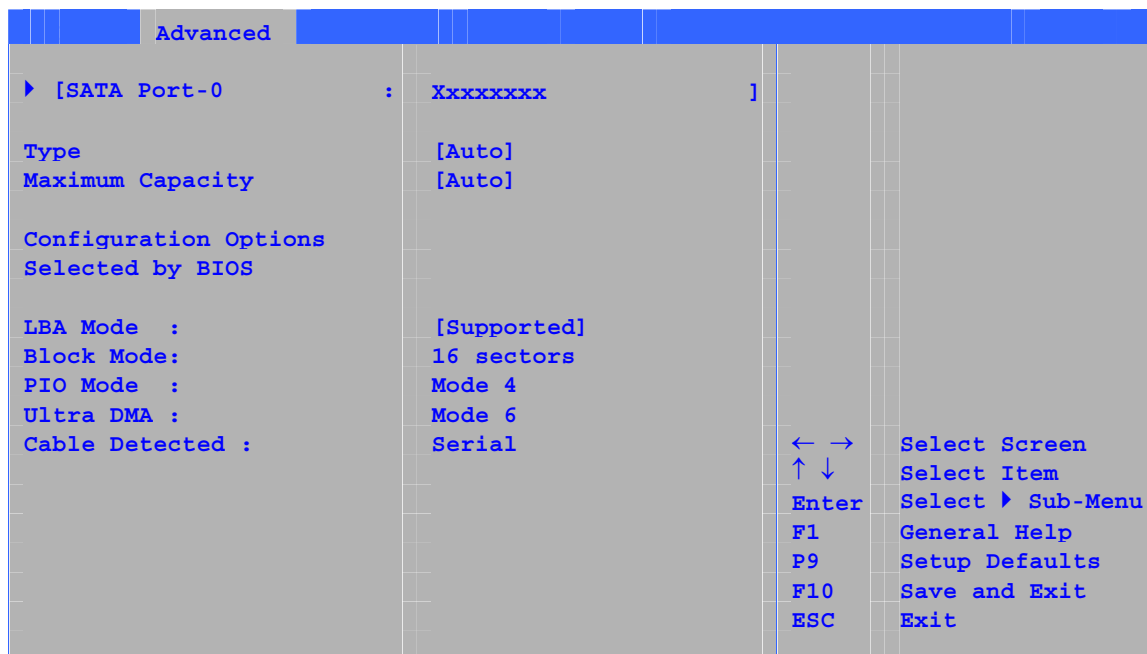

There are four IDE submenus: Primary master, primary slave, secondary master, and secondary slave. Table 21 shows the format of these IDE submenus. For brevity, only one example is shown.

Table 21. SATA and PATA Submenus

Feature	Options	Description
Drive Installed	None	Displays the type of drive installed.
Type	<ul style="list-style-type: none"> • Auto (default) • User 	Specifies the IDE configuration mode for IDE devices. <i>Auto</i> fills-in capabilities from ATA/ATAPI device. <i>User</i> allows capabilities to be changed.
Maximum Capacity	None	Displays the capacity of the drive.
LBA Mode Control (Note)	None	Specifies LBA mode control.
Block Mode	<ul style="list-style-type: none"> • Disabled • Auto (default) 	Check the hard disk drive's specifications for optimum setting.
PIO Mode (Note)	<ul style="list-style-type: none"> • Auto (default) • 0 • 1 • 2 • 3 • 4 	Specifies the PIO mode.

continued

Table 21. SATA and PATA Submenus (continued)

Feature	Options	Description
DMA Mode	<ul style="list-style-type: none"> • Auto (default) • SWDMA 0 • SWDMA 1 • SWDMA 2 • MWDMA 0 • MWDMA 1 • MWDMA 2 • UDMA 0 • UDMA 1 • UDMA 2 • UDMA 3 • UDMA 4 • UDMA 5 	Specifies the Ultra DMA mode for the drive.
S.M.A.R.T.	<ul style="list-style-type: none"> • Auto (default) • Disable • Enable 	Self-monitoring analysis and reporting technology.
Cable Detected (Note)	None	Displays the type of cable connected to the IDE interface: 40-conductor or 80-conductor (for ATA-66/100 devices) or Serial ATA.

Note: These configuration options appear only if an IDE device is installed.

Diskette Configuration Submenu

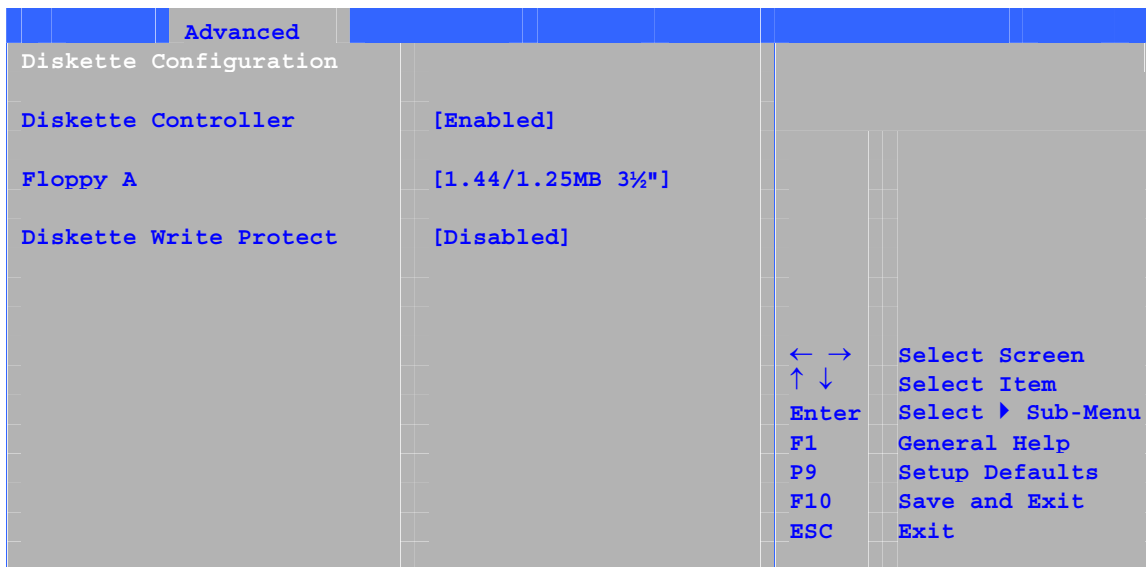

This submenu shown in Table 22 is used to configure the floppy drive.

Table 22. Diskette Configuration Submenu

Feature	Options	Description
Diskette Controller	<ul style="list-style-type: none"> Disabled Enabled (default) 	Configures the integrated floppy controller.
Floppy A	<ul style="list-style-type: none"> Disabled 360 KB 5¼" 1.2 MB 5¼" 720 KB 3½" 1.44 MB 3½" (default) 2.88 MB 3½" 	Selects the floppy drive type.
Diskette Write Protect	<ul style="list-style-type: none"> Disabled (default) Enabled 	Disables or enables diskette drive write protection.

Event Log Configuration Submenu

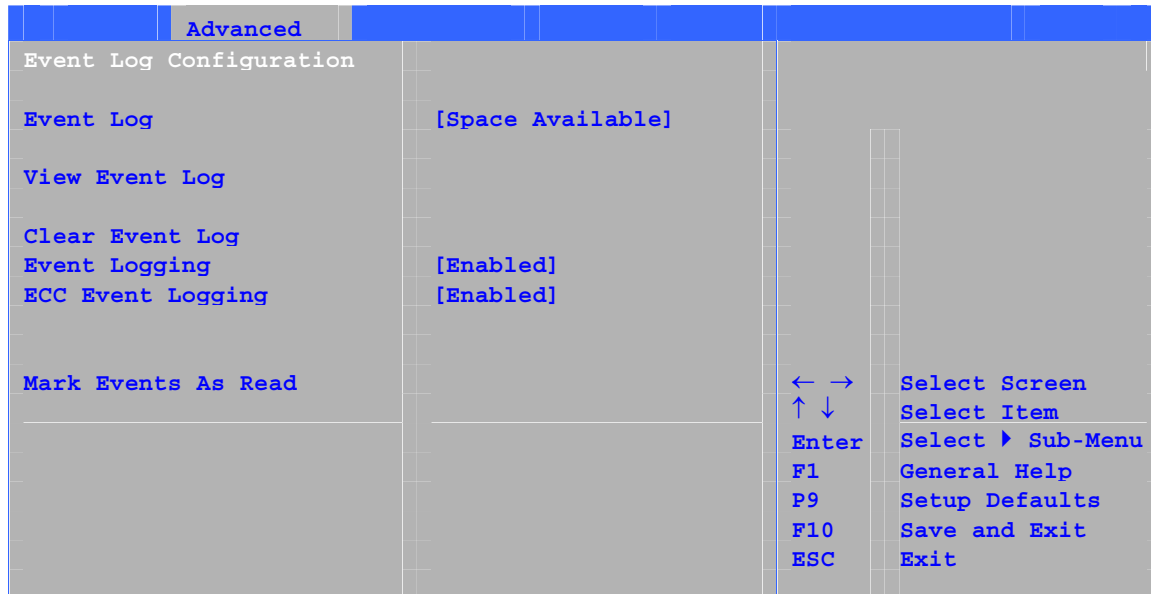

The submenu shown in Table 23 is used to configure the event logging features.

Table 23. Event Log Configuration Submenu

Feature	Options	Description
Event Log	No options	Indicates if there is space available in the event log.
View Event Log	[Enter]	Displays the contents of the DMI event log.
Clear Event Log	No options	Discards all events in the event log.
Event Logging	<ul style="list-style-type: none"> Disabled Enabled (default) 	Enables or disables event logging.
ECC Event Logging	<ul style="list-style-type: none"> Disabled Enabled (default) 	<i>Enabled</i> allows logging of DMI events.
Mark Events As Read	[Enter]	Marks all DMI events in the event log as read.

Video Configuration Submenu

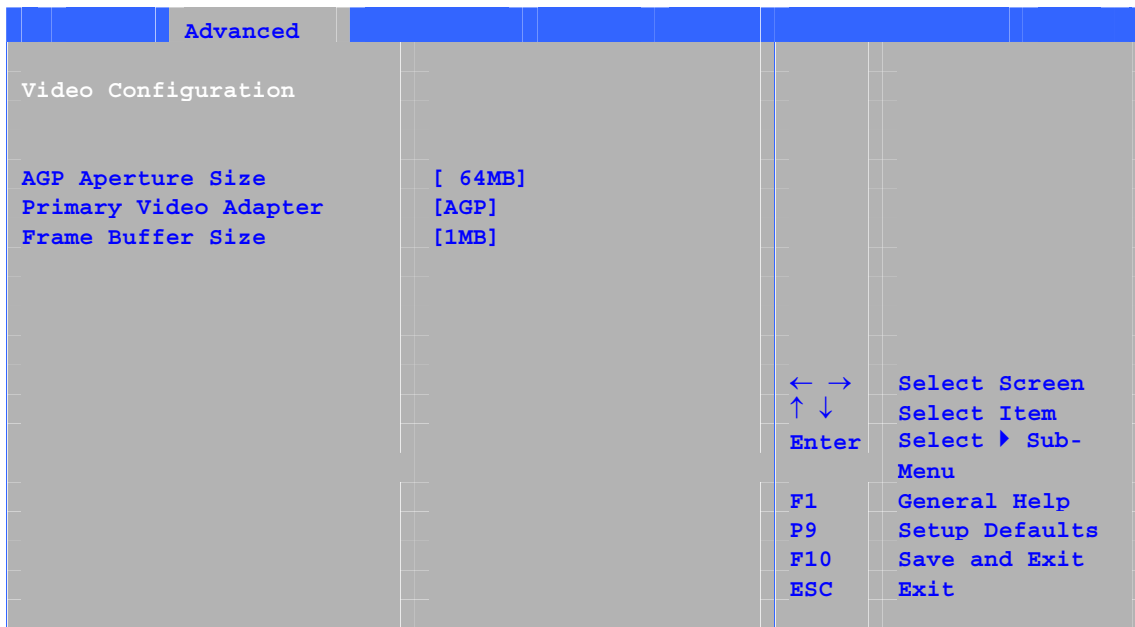

The submenu shown in Table 24 is used to configure video features.

Table 24. Video Configuration Submenu

Feature	Options	Description
AGP Aperture Size	<ul style="list-style-type: none"> • 4 MB • 8 MB • 16 MB • 32 MB • 64 MB (default) • 128 MB • 256 MB 	Amount of system memory available for direct access by the graphics device.
Primary Video Adapter	<ul style="list-style-type: none"> • AGP (default) • PCI 	Allows selecting an AGP or PCI video controller as the display device that will be active when the system boots.
Frame Buffer Size	<ul style="list-style-type: none"> • 512 KB • 1 MB (default) • 8 MB 	Controls how much system RAM is reserved for use by the internal graphics device.

USB Configuration Submenu

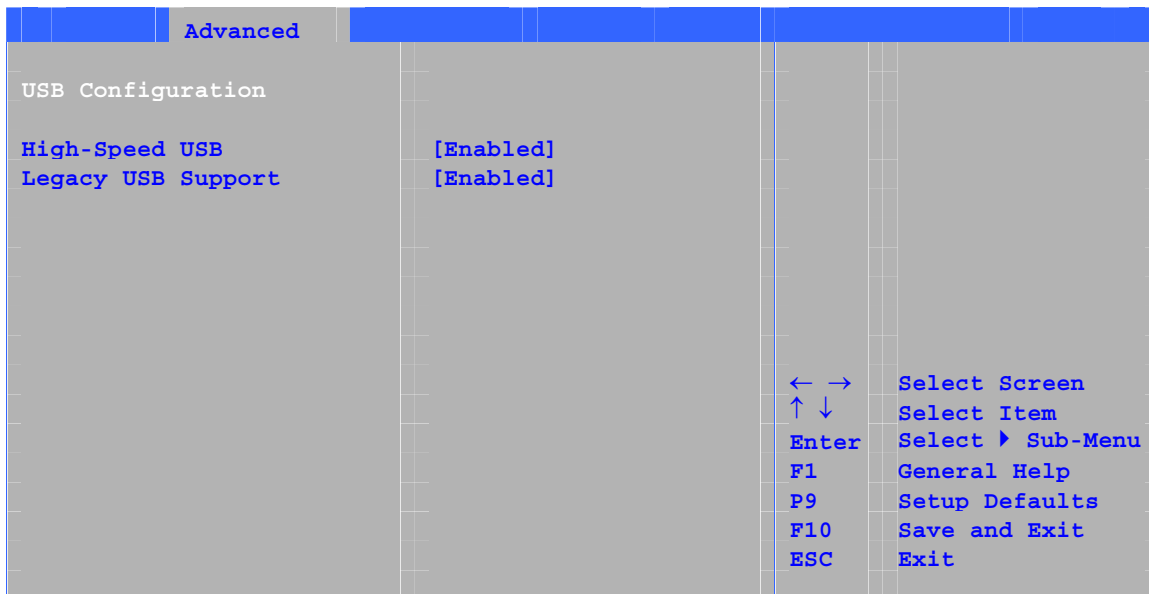

The submenu shown in Table 25 is used to configure USB features.

Table 25. USB Configuration Submenu

Feature	Options	Description
High Speed USB	<ul style="list-style-type: none"> Disabled Enabled (default) 	Disable this option when a USB 2.0 driver is not available.
Legacy USB Support	<ul style="list-style-type: none"> Disabled Enabled (default) 	Enables support for legacy USB.

Chipset Configuration Submenu

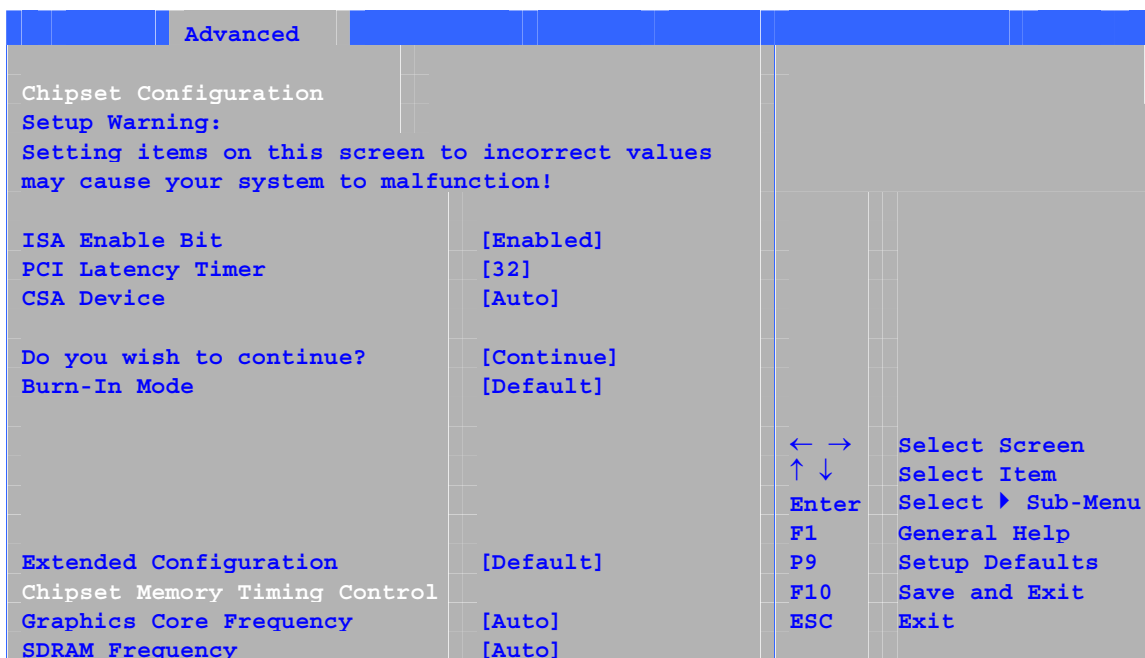

The submenu shown in Table 26 is used to configure advanced chipset features.

Table 26. Chipset Configuration Submenu

Feature	Options	Description
ISA Enable Bit	<ul style="list-style-type: none"> Enabled (default) Disabled 	Some older expansion devices require this option to be enabled.
PCI Latency Timer	<ul style="list-style-type: none"> 32 (default) 64 96 128 160 192 224 248 	Set PCI latency time.
CSA Device	<ul style="list-style-type: none"> Auto (default) Disable 	
Do you wish to continue?	<ul style="list-style-type: none"> No (default) Continue 	
Burn-In Mode	<ul style="list-style-type: none"> Default (default) -2.0% -1.0% +1.0% +2.0% +3.0% +4.0% 	Alters host and I/O clock frequencies.

continued

Table 25. Chipset Configuration Submenu (continued)

Feature	Options	Description
Extended Configuration	<ul style="list-style-type: none"> • Default (default) • User Defined 	Chooses the default or user defined settings for the extended configuration options.
Graphics Core Frequency	<ul style="list-style-type: none"> • Auto (default) • 266 MHz • 333-320 MHz 	Allows override of detected graphics core frequency value.
SDRAM Frequency	<ul style="list-style-type: none"> • Auto (default) • 266 MHz • 333 MHz • 400 MHz 	Allows override of detected memory frequency value.
SDRAM Timing Control	<ul style="list-style-type: none"> • Auto (default) • Manual – Aggressive • Manual – User Defined 	<p><i>Auto</i> allows timings to be programmed according to the memory detected.</p> <p><i>Manual – Aggressive</i> selects the most aggressive user defined timings.</p> <p><i>Manual – User Defined</i> allows manual override of detected SDRAM settings.</p>
CPC Override	<ul style="list-style-type: none"> • Auto (default) • Enabled • Disabled 	Controls Command Per Clock/1n rule mode. When enabled, allows DRAM controller to attempt Chip Select assertions in two consecutive common clocks.
SDRAM RAS Act. To Pre.	<ul style="list-style-type: none"> • 8 (default) • 7 • 6 • 5 	Selects length of time from read to pre-change. Corresponds to tRAS, min.
SDRAM CAS# Latency	<ul style="list-style-type: none"> • 2.0 • 2.5 • 3.0 (default) 	Selects the number of clock cycles required to address a column in memory. Corresponds to CL.
SDRAM RAS# to CAS# delay	<ul style="list-style-type: none"> • 4 • 3 (default) • 2 	Selects the number of clock cycles between addressing a row and addressing a column. Corresponds to tRCD.
SDRAM RAS# Precharge	<ul style="list-style-type: none"> • 4 • 3 (default) • 2 	Selects the length of time required before accessing a new row.

Fan Control Submenu

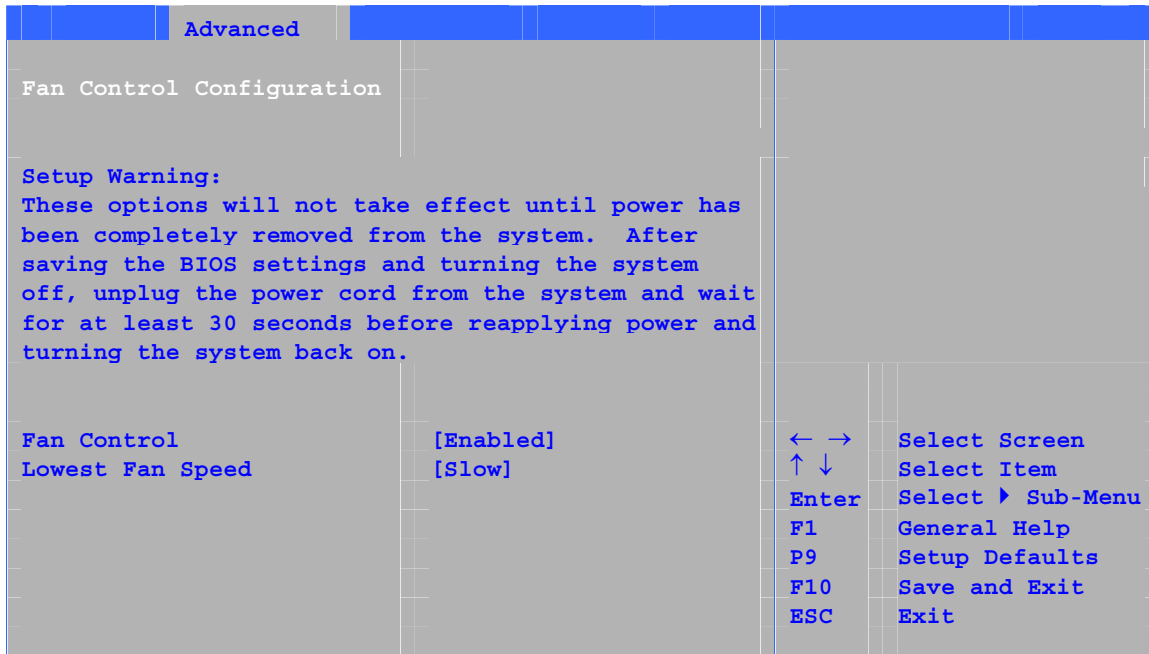

The menu shown in Table 27 is used to configure hardware management features.

Table 27. Hardware Management

Feature	Options	Description
Fan Control	<ul style="list-style-type: none"> Disabled Enabled (default) 	Disables or enables system fan control.
Lowest Fan Speed	<ul style="list-style-type: none"> Slow (default) Off 	This option defines the fan speed at the lowest system temperature. <i>Slow</i> allows the fans to continue to run at a reduced speed at low system temperatures. <i>Off</i> turns off the fans at low system temperatures.

Hardware Monitoring Submenu

Advanced			
Hardware Monitoring			
Note: These measurements are approximate and should not be used for validation purposes.			
Processor Zone Temperature	44°C/111°F		
System Zone 1 Temperature	37°C/98°F		
System Zone 2 Temperature	35°C/95°F		
Processor Fan Speed	2394 RPM		
Rear Fan Speed (J1B1)	0 RPM		
Rear Fan Speed (J5B1)	0 RPM		
Front Fan Speed	0 RPM	← →	Select Screen
		↑ ↓	Select Item
		Enter	Select ▶ Sub-Menu
+1.5Vin	1.480 V	F1	General Help
Vccp	1.447 V	P9	Setup Defaults
+3.3Vin	3.258 V	F10	Save and Exit
+5Vin	5.026 V	ESC	Exit
12Vin	11.625 V		

Table 28. Hardware Monitoring Submenu

Feature	Options	Description
Processor Zone Temperature	No option	Displays processor zone temperature.
System Zone 1 Temperature	No option	Displays system zone 1 temperature.
System Zone 2 Temperature	No option	Displays system zone 2 temperature.
Processor Fan Speed	No option	Displays processor fan speed.
Rear Fan Speed	No option	Displays rear fan speed.
VREG Fan Speed	No option	Displays VREG fan speed.
Front Fan Speed	No option	Displays front fan speed.

Security Menu

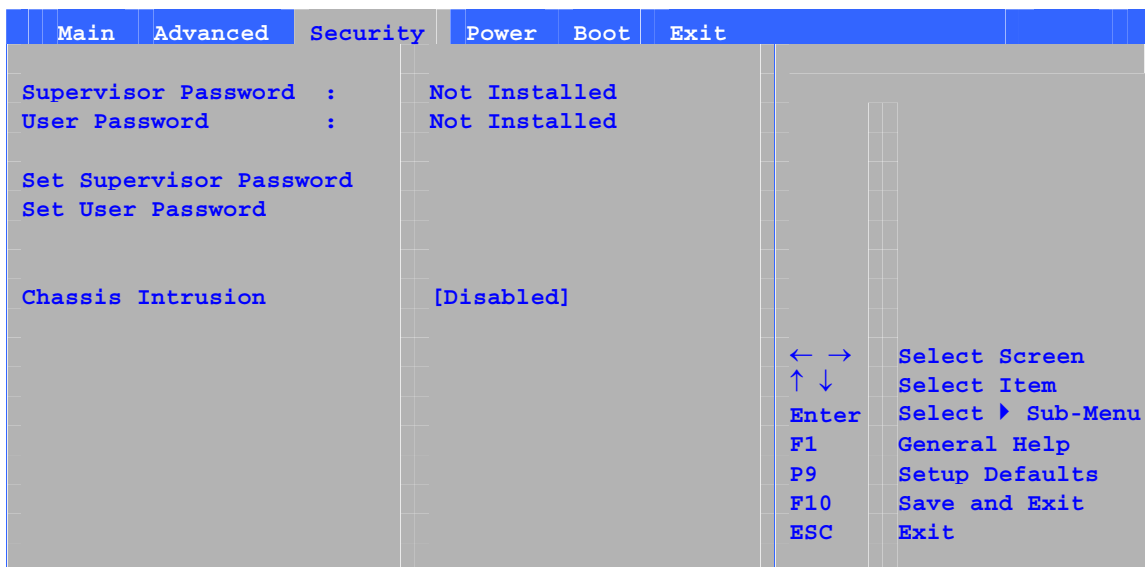

The menu shown in Table 29 is used to set passwords and security features.

Table 29. Security Menu

If no password entered previously:		
Feature	Options	Description
Supervisor Password	No options	Reports if there is a supervisor password set.
User Password	No options	Reports if there is a user password set.
Set Supervisor Password	Password can be up to seven alphanumeric characters.	Specifies the supervisor password.
Set User Password	Password can be up to seven alphanumeric characters.	Specifies the user password.
Clear User Password (Note 1)	<ul style="list-style-type: none"> • Yes (default) • No 	Clears the user password.
User access Level (Note 2)	<ul style="list-style-type: none"> • Limited • No access • View Only • Full (default) 	Sets BIOS Setup Utility access rights for user level.
Chassis Intrusion	<ul style="list-style-type: none"> • Disabled (default) • Enabled 	Enables or disables the chassis intrusion feature.

Notes:

1. This feature appears only if a user password has been set.
2. This feature appears only if both a user password and a supervisor password have been set.

Power Menu

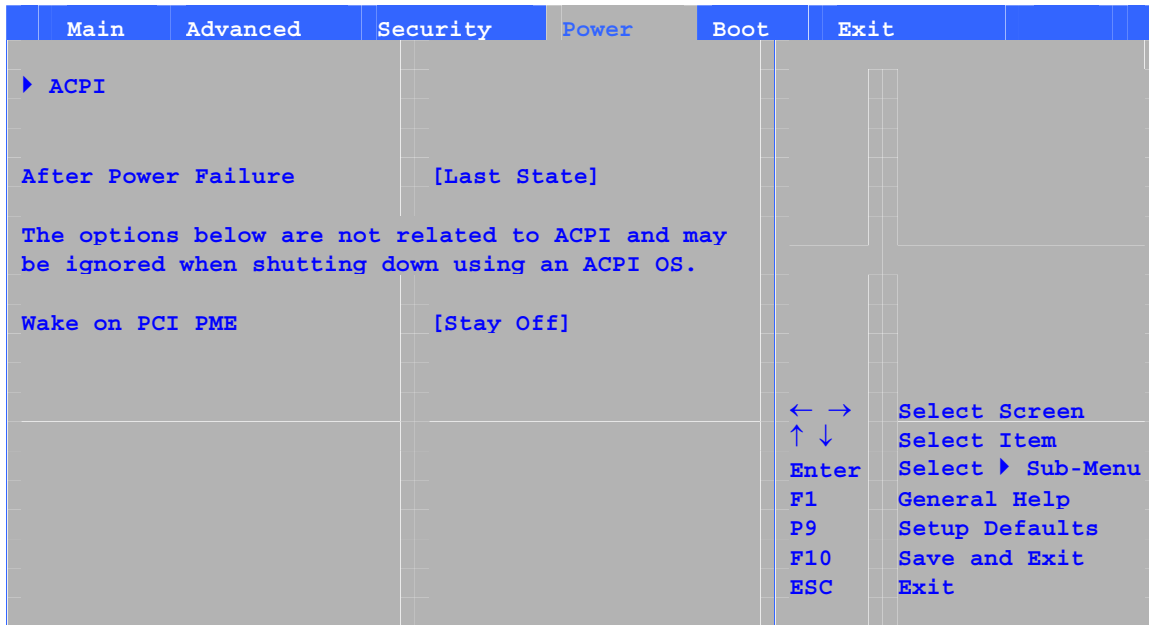

The menu shown in Table 30 is used to set power management features.

Table 30. Power Menu

Feature	Options	Description
ACPI	No Options	When selected, displays the ACPI submenu.
After Power Failure	<ul style="list-style-type: none"> Stay Off Last State (default) Power On 	Determines the mode of operation if a power loss occurs. <i>Stay Off</i> keeps the power off until the power button is pressed. <i>Last State</i> restores the previous power state before power loss occurred. <i>Power On</i> restores power to the computer.
Wake on PCI PME	<ul style="list-style-type: none"> Stay Off (default) Power-On 	Determines how the system responds to a PCI-PME wake up event.

ACPI Submenu

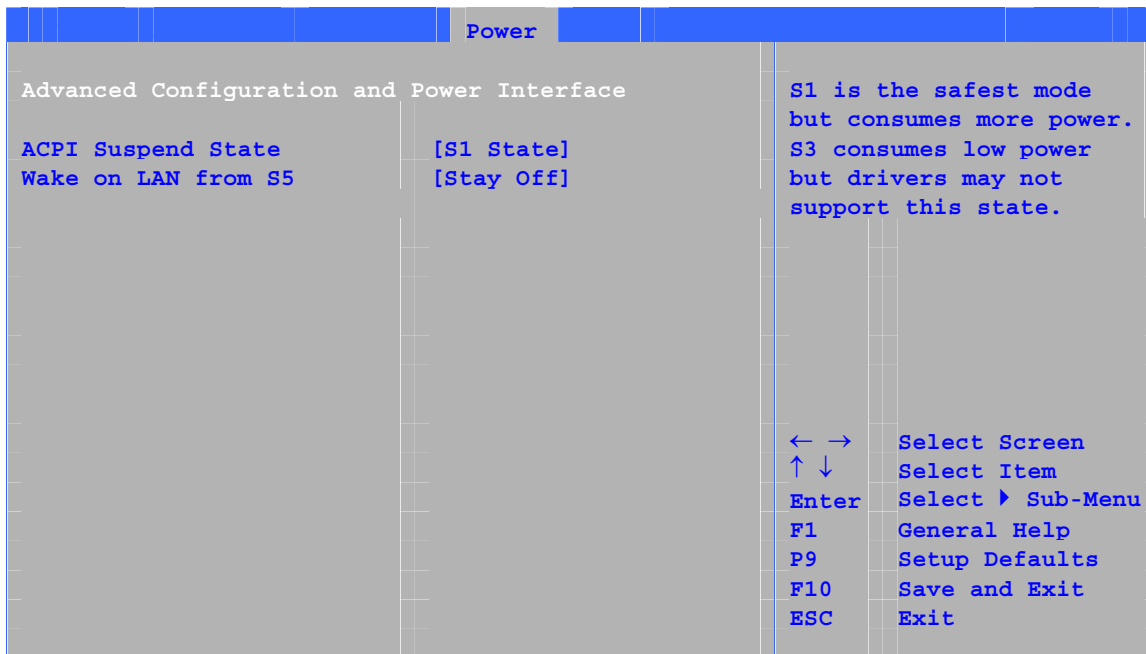

The submenu represented in Table 31 is for setting the ACPI features.

Table 31. ACPI Submenu

Feature	Options	Description
ACPI Suspend Mode	<ul style="list-style-type: none"> • S1 State (default) • S3 State 	Specifies the ACPI sleep state.
Wake on LAN* from S5	<ul style="list-style-type: none"> • Stay Off (default) • Power On 	In ACPI soft-off mode only, determines how the system responds to a LAN wake up event when the system is in the ACPI soft-off mode.

Boot Menu

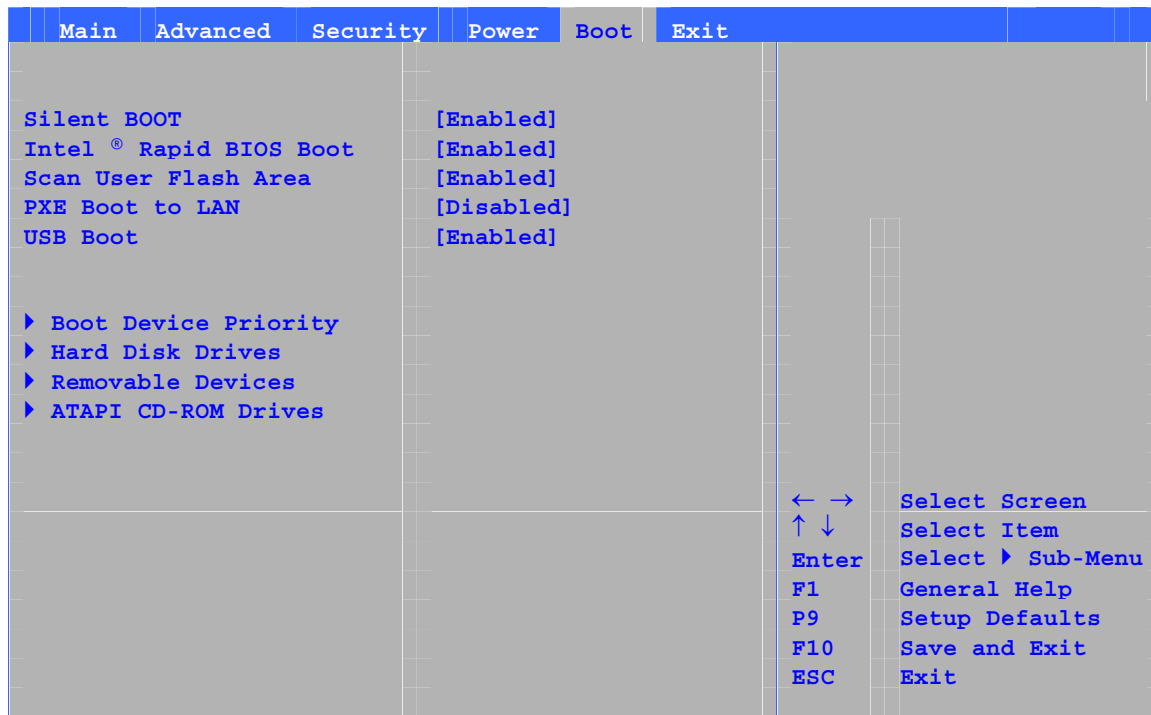

The menu shown in Table 32 is used to set the boot features and the boot sequence.

Table 32. Boot Menu

Feature	Options	Description
Silent Boot	<ul style="list-style-type: none"> Disabled Enabled (default) 	<p><i>Disabled</i> displays normal POST messages.</p> <p><i>Enabled</i> displays OEM logo instead of POST messages.</p>
Intel® Rapid BIOS Boot	<ul style="list-style-type: none"> Disabled Enabled (default) 	Allows BIOS to skip certain tests while booting.
Scan User Flash Area	<ul style="list-style-type: none"> Disabled Enabled (default) 	Enables the BIOS to scan the flash ROM for user binary files that are executed at boot time.
PXE Boot to LAN	<ul style="list-style-type: none"> Disabled (default) Enabled 	Disables or enables PXE boot to LAN.
USB Boot	<ul style="list-style-type: none"> Disabled Enabled (default) 	Disables or enables booting to USB boot devices.
Boot Device Priority	No options	Specifies the boot sequence from the available types of boot devices.
Hard Disk Drives	No options	Specifies the boot sequence from the available hard disk drives.
Removable Devices	No options	Specifies the boot sequence from the available removable devices.
ATAPI CD-ROM Drives	No options	Specifies the boot sequence from the available ATAPI CD-ROM drives.

Boot Device Priority Submenu

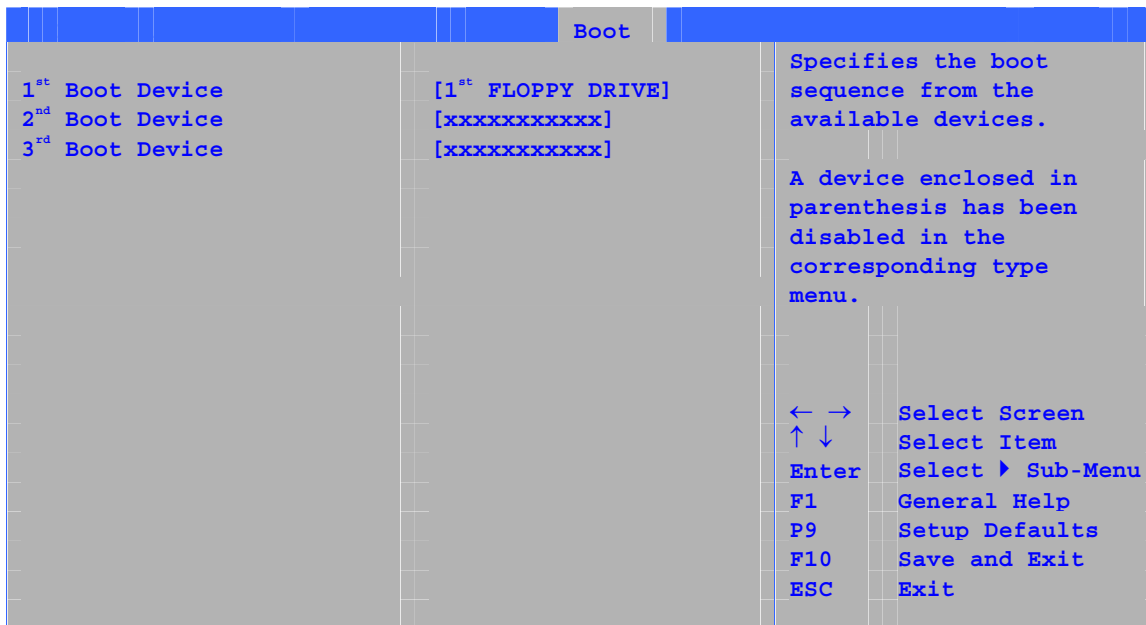

The submenu represented in Table 33 is for setting boot devices priority.

Table 33. Boot Device Priority Submenu

Feature	Options	Description
1 st Boot Device 2 nd Boot Device 3 rd Boot Device	<ul style="list-style-type: none"> Removable Device Hard Drive ATAPI CD-ROM Disabled 	<p>Specifies the boot sequence from the available devices. To specify boot sequence:</p> <ol style="list-style-type: none"> Select the boot device with <↑> or <↓>. Press <Enter> to set the selection as the intended boot device. <p>The operating system assigns a drive letter to each boot device in the order listed. Changing the order of the devices changes the drive lettering. The default settings for the first through final boot devices are, respectively listed below. The BIOS supports up to sixteen total boot devices in any combination of the boot device types below, with respect to these maximums per type.</p> <ul style="list-style-type: none"> Removable Device (maximum of four). Hard Drive (maximum of 12). ATAPI CD-ROM (maximum of four). A device enclosed in parenthesis has been disabled in the corresponding type menu.

Hard Disk Drives Submenu

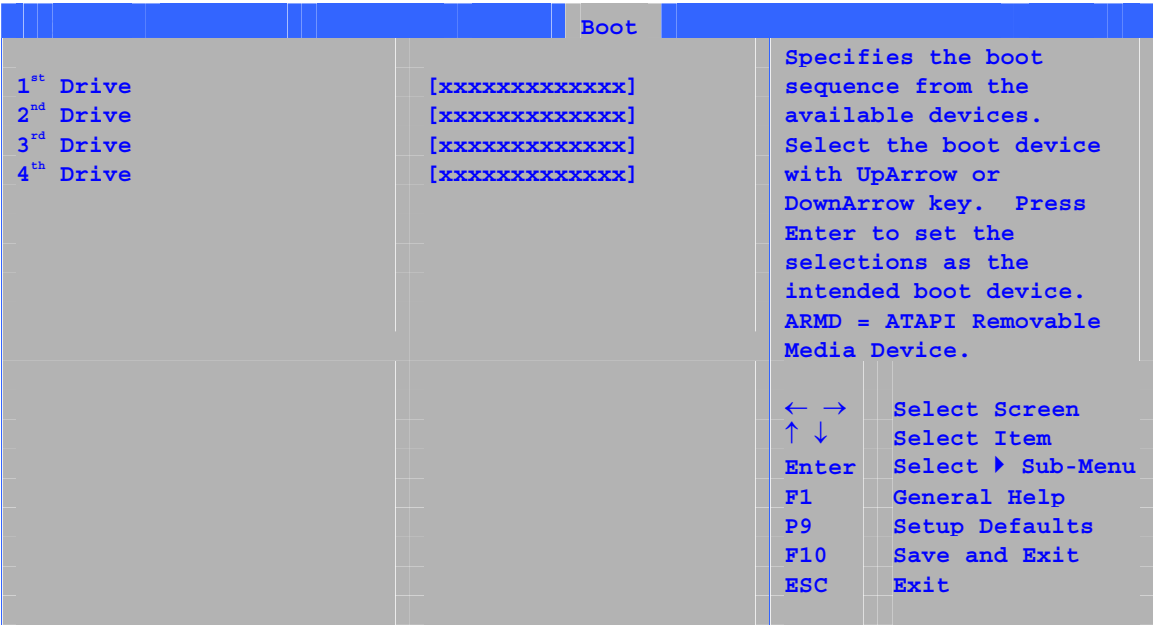

The submenu shown in Table 34 is for setting hard disk drives.

Table 34. Hard Disk Drives Submenu

Feature	Options	Description
1 st Hard Disk Drive (Note)	Dependent on installed hard drives	Specifies the boot sequence from the available hard disk drives. To specify boot sequence: 1. Select the boot device with <↑> or <↓>. 2. Press <Enter> to set the selection as the intended boot device.

Note: This boot device submenu appears only if at least one boot device of this type is installed. This list will display up to 12 hard disk drives, the maximum number of hard disk drives supported by the BIOS.

Removable Devices Submenu

		Boot
1 st Drive	[1 st FLOPPY DRIVE]	<p>Specifies the boot sequence from the available devices. Select the boot device with UpArrow or DownArrow key. Press Enter to set the selections as the intended boot device. ARMD = ATAPI Removable Media Device.</p> <p>← → Select Screen ↑ ↓ Select Item Enter Select ▶ Sub-Menu F1 General Help P9 Setup Defaults F10 Save and Exit ESC Exit</p>

The submenu in shown Table 35 is for setting removable devices.

Table 35. Removable Devices Submenu

Feature	Options	Description
1 st Removable Device (Note)	Dependent on installed removable devices	<p>Specifies the boot sequence from the available removable devices. To specify boot sequence:</p> <ol style="list-style-type: none"> 1. Select the boot device with <↑> or <↓>. 2. Press <Enter> to set the selection as the intended boot device.

Note: This boot device submenu appears only if at least one boot device of this type is installed. This list will display up to four removable devices, the maximum number of removable devices supported by the BIOS.

ATAPI CD-ROM Drives

		Boot	
1st Drive	[xxxxxxx]		Specifies the boot sequence from the available devices. Select the boot device with UpArrow or DownArrow key. Press Enter to set the selections as the intended boot device. ARMD = ATAPI Removable Media Device.
2 nd Drive	[xxxxxxx]		
			← → Select Screen ↑ ↓ Select Item Enter Select ▶ Sub-Menu F1 General Help P9 Setup Defaults F10 Save and Exit ESC Exit

The submenu shown in Table 36 is for setting ATAPI CD-ROM drives.

Table 36. ATAPI CD-ROM Drives Submenu

Feature	Options	Description
1 st ATAPI CD-ROM Drive (Note)	Dependent on installed ATAPI CD-ROM drives	Specifies the boot sequence from the available ATAPI CD-ROM drives. To specify boot sequence: <ol style="list-style-type: none"> 1. Select the boot device with <↑> or <↓>. 2. Press <Enter> to set the selection as the intended boot device.

Note: This boot device submenu appears only if at least one boot device of this type is installed. This list will display up to four ATAPI CD-ROM drives, the maximum number of ATAPI CD-ROM drives supported by the BIOS.

Exit Menu

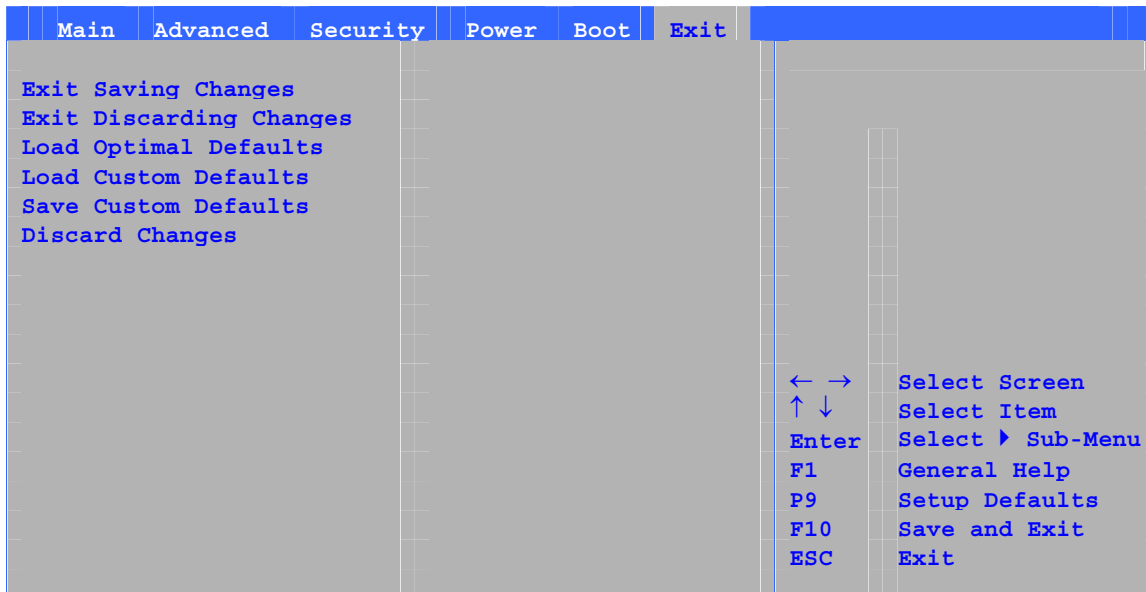

The menu shown in Table 37 is used to exit the BIOS Setup program, saving changes, and loading and saving defaults.

Table 37. Exit Menu

Feature	Description
Exit Saving Changes	Exits and saves the changes in CMOS SRAM.
Exit Discarding Changes	Exits without saving any changes made in the BIOS Setup program.
Load Optimal Defaults	Loads optimal defaults.
Load Custom Defaults	Loads the custom defaults for Setup options.
Save Custom Defaults	Saves the current values as custom defaults. Normally, the BIOS reads the Setup values from flash memory. If this memory is corrupted, the BIOS reads the custom defaults. If no custom defaults are set, the BIOS reads the factory defaults.
Discard Changes	Discards changes without exiting Setup. The option values present when the computer was turned on are used.

5 Technical Reference

Board Connectors

This chapter shows the location of the:

- Back panel connectors
- Audio connectors
- Add-in board and peripheral interface connectors



CAUTION

Many of the midboard and front panel connectors provide operating voltage (+5 V dc and +12 V dc, for example) to devices inside the computer chassis, such as fans and internal peripherals. These connectors are not overcurrent protected. Do not use these connectors for powering devices external to the computer chassis. A fault in the load presented by the external devices could cause damage to the computer, the interconnecting cable, and the external devices themselves.

Back Panel Connectors



NOTE

The line out connector, located on the back panel, is designed to power either headphones or amplified speakers only. Poor audio quality may occur if passive (non-amplified) speakers are connected to this output.

Figure 18 shows the back panel connectors.

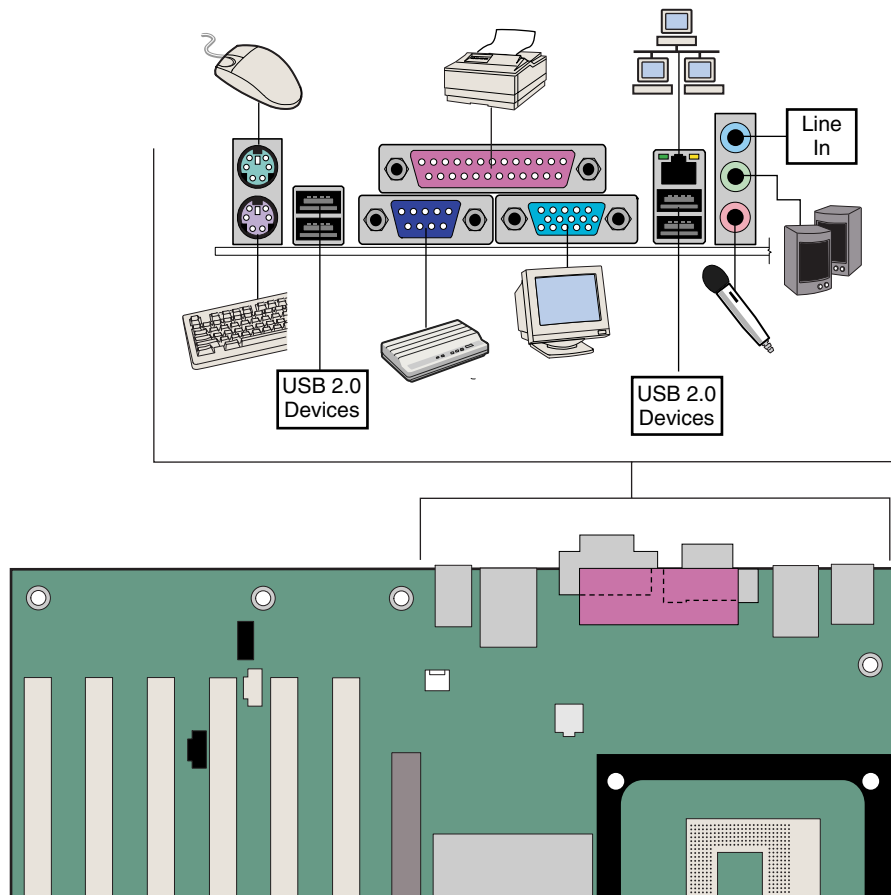

OM15235

Figure 18. Back Panel Connectors

Audio Connectors

Figure 13 shows the approximate location of the audio connectors.

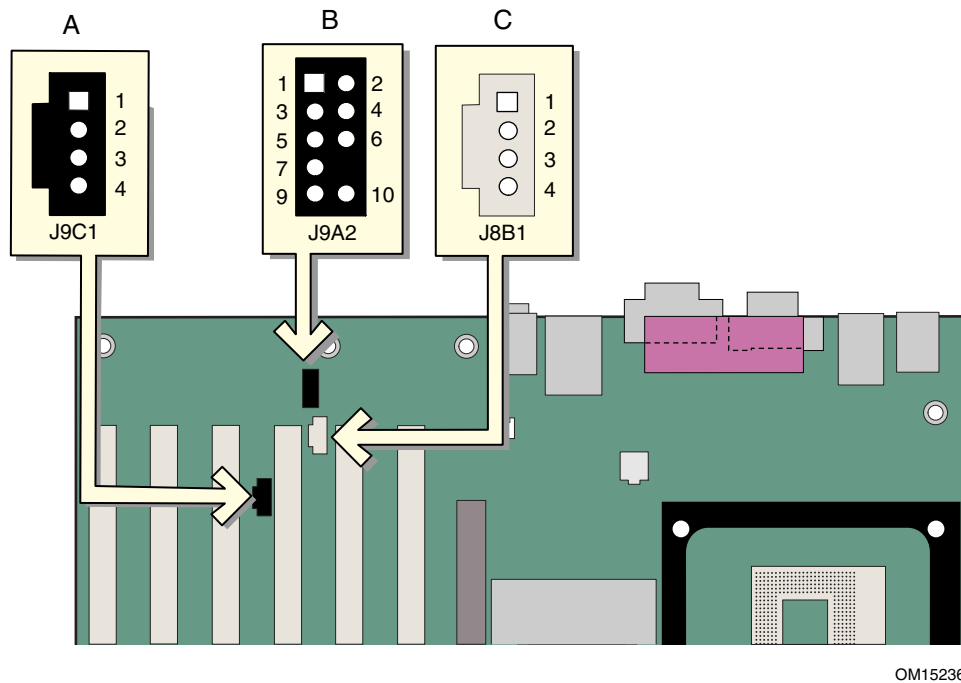

OM15236

Item	Description
A	CD-ROM (ATAPI-style)
B	Front panel audio
C	Auxiliary line in (ATAPI-style)

Figure 19. Audio Connectors

Add-In Card and Peripheral Interface Connectors

Figure 20 shows the PCI bus add-in card and peripheral interface connectors for Desktop Board D865GBF. Desktop Board D865GLC has three PCI bus add-in card connectors.

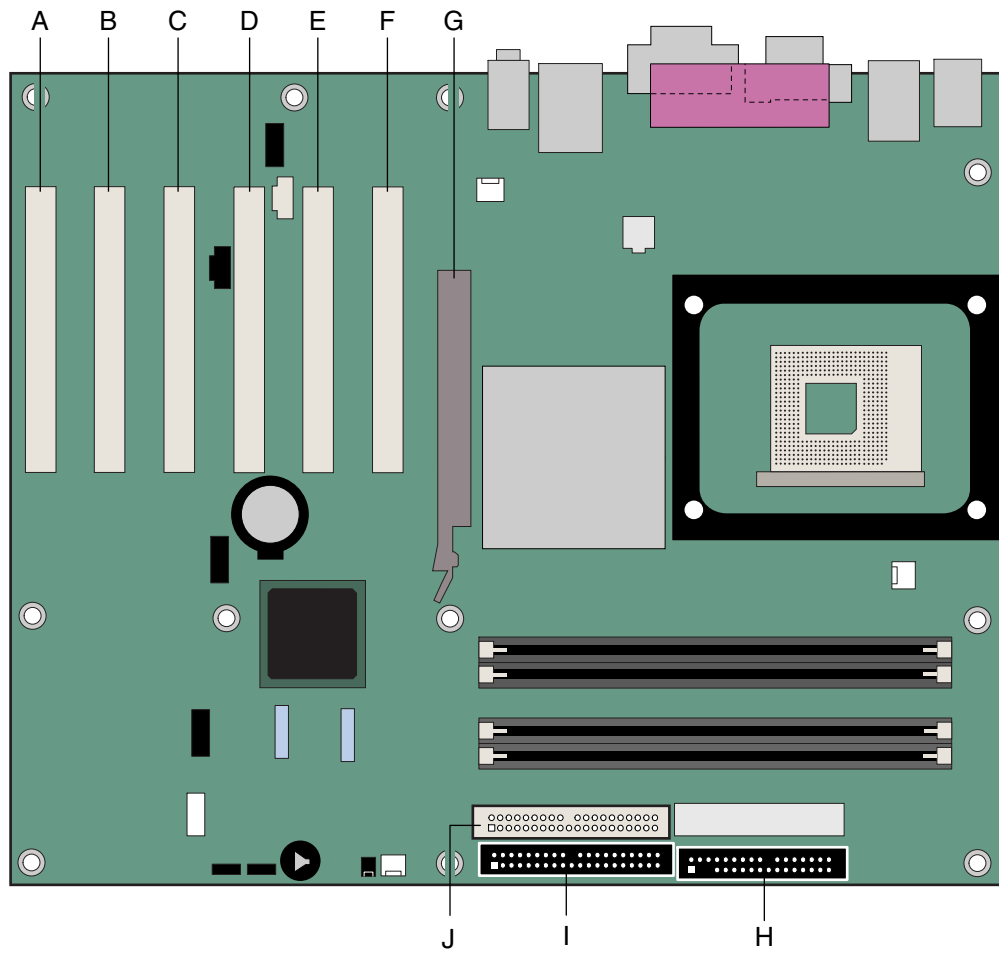

OM15238

Item	Description	Item	Description
A	PCI bus add-in card connector 6	F	PCI bus add-in card connector 1
B	PCI bus add-in card connector 5	G	AGP
C	PCI bus add-in card connector 4	H	Floppy drive
D	PCI bus add-in card connector 3	I	Primary IDE
E	PCI bus add-in card connector 2 (SMBus routed)	J	Secondary IDE

Figure 20. PCI Bus Add-in Card and Peripheral Interface Connectors

Desktop Board Resources

Memory Map

Table 38. System Memory Map

Address Range (decimal)	Address Range (hex)	Size	Description
1024 K - 4194304 K	100000 - FFFFFFFF	4095 MB	Extended Memory
960 K - 1024 K	F0000 - FFFFF	64 KB	Runtime BIOS
896 K - 960 K	E0000 - EFFFF	64 KB	Reserved
800 K - 896 K	C8000 - DFFFF	96 KB	Available high DOS memory (open to the PCI bus)
640 K - 800 K	A0000 - C7FFF	160 KB	Video memory and BIOS
639 K - 640 K	9FC00 - 9FFFF	1 KB	Extended BIOS data (movable by memory manager software)
512 K - 639 K	80000 - 9FBFF	127 KB	Extended conventional memory
0 K - 512 K	00000 - 7FFFF	512 KB	Conventional memory

DMA Channels

Table 39. DMA Channels

DMA Channel Number	Data Width	System Resource
0	8 or 16 bits	
1	8 or 16 bits	Parallel port
2	8 or 16 bits	Floppy drive
3	8 or 16 bits	Parallel port (for ECP or EPP)
4	8 or 16 bits	DMA controller
5	16 bits	Open
6	16 bits	Open
7	16 bits	Open

Interrupts

Table 40. Interrupts

IRQ	System Resource
NMI	I/O channel check
0	Reserved, interval timer
1	Reserved, keyboard buffer full
2	Reserved, cascade interrupt from slave PIC
3	COM2*
4	COM1*
5	LPT2 (Plug and Play option) **
6	Floppy drive controller
7	LPT1*
8	Real time clock
9	**
10	**
11	**
12	Onboard mouse port (if present, else user available)
13	Reserved, math coprocessor
14	Primary IDE (if present, else user available)
15	Secondary IDE (if present, else user available)

* Default, but can be changed to another IRQ.

** Dynamically allocated for all PCI/AGP devices and slots.

A Error Messages and Indicators

Desktop Board D865GBF/D865GLC reports POST errors in two ways:

- By sounding a beep code
- By displaying an error message on the monitor

BIOS Beep Codes

The BIOS beep codes are listed in Table 41. The BIOS also issues a beep code (one long tone followed by two short tones) during POST if the video configuration fails (a faulty video card or no card installed) or if an external ROM module does not properly checksum to zero.

Table 41. Beep Codes

Number of Beeps	Description
1	Refresh failure
2	Parity cannot be reset
3	First 64 K memory failure
4	Timer not operational
5	Processor failure (Reserved; not used)
6	8042 GateA20 cannot be toggled (memory failure or not present)
7	Exception interrupt error
8	Display memory R/W error
9	(Reserved; not used)
10	CMOS Shutdown register test error
11	Invalid BIOS (such as, POST module not found)

BIOS Error Messages

When a recoverable error occurs during the POST, the BIOS displays an error message describing the problem.

Table 42. BIOS Error Messages

Error Message	Explanation
GA20 Error	An error occurred with Gate-A20 when switching to protected mode during the memory test.
Pri Master HDD Error Pri Slave HDD Error Sec Master HDD Error Sec Slave HDD Error	Could not read sector from corresponding drive.
Pri Master Drive - ATAPI Incompatible Pri Slave Drive - ATAPI Incompatible Sec Master Drive - ATAPI Incompatible Sec Slave Drive - ATAPI Incompatible	Corresponding drive is not an ATAPI device. Run Setup to make sure device is selected correctly.
A: Drive Error B: Drive Error	No response from the diskette drive.
CMOS Battery Low	The battery may be losing power. Replace the battery soon.
CMOS Display Type Wrong	The display type is different than what has been stored in CMOS. Check Setup to make sure type is correct.
CMOS Checksum Bad	The CMOS checksum is incorrect. CMOS memory may have been corrupted. Run Setup to reset values.
CMOS Settings Wrong	CMOS values are not the same as the last boot. These values have either been corrupted or the battery has failed.
CMOS Date/Time Not Set	The time and/or date values stored in CMOS are invalid. Run Setup to set correct values.
DMA Error	Error during read/write test of DMA controller.
FDC Failure	Error occurred trying to access diskette drive controller.
HDC Failure	Error occurred trying to access hard disk controller.
Checking NVRAM.....	NVRAM is being checked to see if it is valid.
Update OK!	NVRAM was invalid and has been updated.
Updated Failed	NVRAM was invalid but was unable to be updated.
Keyboard Is Locked	The system keyboard lock is engaged. The system must be unlocked to continue to boot.
Keyboard Error	Error in the keyboard connection. Make sure keyboard is connected properly.
KB/Interface Error	Keyboard interface test failed.

continued

Table 42. BIOS Error Messages (continued)

Error Message	Explanation
Memory Size Decreased	Memory size has decreased since the last boot. If no memory was removed, then memory may be bad.
Memory Size Increased	Memory size has increased since the last boot. If no memory was added, there may be a problem with the system.
Memory Size Changed	Memory size has changed since the last boot. If no memory was added or removed, then memory may be bad.
No Boot Device Available	System did not find a device to boot.
Off Board Parity Error	A parity error occurred on an offboard card. This error is followed by an address.
On Board Parity Error	A parity error occurred in onboard memory. This error is followed by an address.
Parity Error	A parity error occurred in onboard memory at an unknown address.
NVRAM / CMOS / PASSWORD cleared by Jumper	NVRAM, CMOS, and passwords have been cleared. The system should be powered down and the jumper removed.
<CTRL_N> Pressed	CMOS is ignored and NVRAM is cleared. User must enter Setup.

B Regulatory Compliance

This appendix contains safety standards, electromagnetic compatibility (EMC) regulations, and product certification markings for Desktop Board D865GBF/D865GLC.

Safety Regulations

Desktop Board D865GBF/D865GLC complies with the safety regulations stated in Table 43 when correctly installed in a compatible host system.

Table 43. Safety Regulations

Regulation	Title
CSA C22.2 No. 60950/ UL 60950, 3 rd Edition, 2000	Bi-National Standard for Safety of Information Technology Equipment including Electrical Business Equipment. (USA and Canada)
EN 60950, 2 nd Edition, 1992 (with Amendments 1, 2, 3, and 4)	The Standard for Safety of Information Technology Equipment including Electrical Business Equipment. (European Union)
IEC 60950, 2 nd edition, 1991 (with Amendments 1, 2, 3, and 4)	The Standard for Safety of Information Technology Equipment including Electrical Business Equipment. (International)
EMKO-TSE (74-SEC) 207/94	Summary of Nordic deviations to EN 60950. (Norway, Sweden, Denmark, and Finland)

EMC Regulations

Desktop Board D865GBF/D865GLC complies with the EMC regulations stated in Table 44 when correctly installed in a compatible host system.

Table 44. EMC Regulations

Regulation	Title
FCC Class B	Title 47 of the Code of Federal Regulations, Parts 2 and 15, Subpart B, Radiofrequency Devices. (USA)
ICES-003 (Class B)	Interference-Causing Equipment Standard, Digital Apparatus. (Canada)
EN55022: 1998 (Class B)	Limits and methods of measurement of Radio Interference Characteristics of Information Technology Equipment. (European Union)
EN55024: 1998	Information Technology Equipment – Immunity Characteristics Limits and methods of measurement. (European Union)
AS/NZS 3548 (Class B)	Australian Communications Authority, Standard for Electromagnetic Compatibility. (Australia and New Zealand)
CISPR 22, 3 rd Edition, (Class B)	Limits and methods of measurement of Radio Disturbance Characteristics of Information Technology Equipment. (International)
CISPR 24: 1997	Information Technology Equipment – Immunity Characteristics – Limits and Methods of Measurement. (International)

Product Certification Markings

Desktop Board D865GBF/D865GLC has the following product certification markings:

- UL joint US/Canada Recognized Component mark: consists of small c followed by a stylized backward UR and followed by a small US. Includes adjacent UL file number for Intel desktop boards: E210882 (component side).
- FCC Declaration of Conformity logo mark for Class B equipment; includes Intel name and model designation (solder side).
- CE mark: declaring compliance to European Union (EU) EMC directive (89/336/EEC) and Low Voltage directive (73/23/EEC) (component side).
- Australian Communications Authority (ACA) C-Tick mark: consists of a stylized C overlaid with a check (tick) mark (component side), followed by Intel supplier code number, N-232.
- Printed wiring board manufacturer's recognition mark: consists of a unique UL recognized manufacturer's logo, along with a flammability rating (94V-0) (solder side).
- Battery "+ Side Up" marking: located on the component side of the board in close proximity to the battery holder.
- Korean MIC logo mark: denotes Korean EMC certification (component side). Additional certification information is provided below:
 1. Product Name (model)
 2. Certificate ID
 3. Applicant: Intel Korea Ltd.
 4. Date of manufacture as separate marking on product
 5. Manufacturer (country of origin)

Korean MIC logo mark for Desktop Board D865GLC

Korean MIC logo mark for Desktop Board D865GBF

- Korean Class B statement translated as follows: this is household equipment that is certified to comply with EMC requirements. You may use this equipment in residential environments and other non-residential environments.

이 기기는 가정용으로 전자파적합등록을 한 기기로서
주거지역에서는 물론 모든 지역에서 사용할 수 있습니다.

